

ART. 0R07S --- A

120V ~ 60Hz

7xMAX 10W T3 G4 12V 

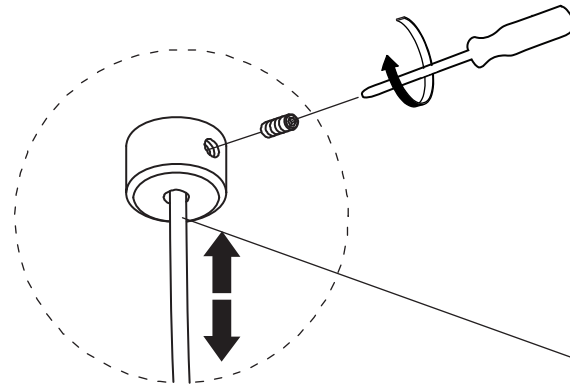

In case of wire change length: cutting of wires must be done by a person aware of the construction and operation of the product and the hazards involved. Do not cut wires from lamp holder side but from cable clamp side.

