

Frame, nature's, *imprint.*

design Terzani Lab
terzani.com



Product Name
Frame
small cylinder pendant light

Materials
clear





Finishes | Code

-  white | clear
0Q01S E8 A9
-  coral | clear
0Q01S H1 A9
-  silver | clear
0Q01S G7 A9
-  gold plated | clear
0Q01S L6 A9



Light source
120V ~ 50/60Hz

-  LED
4W E12 dimmable
- dimmable options**
-  all systems

Body

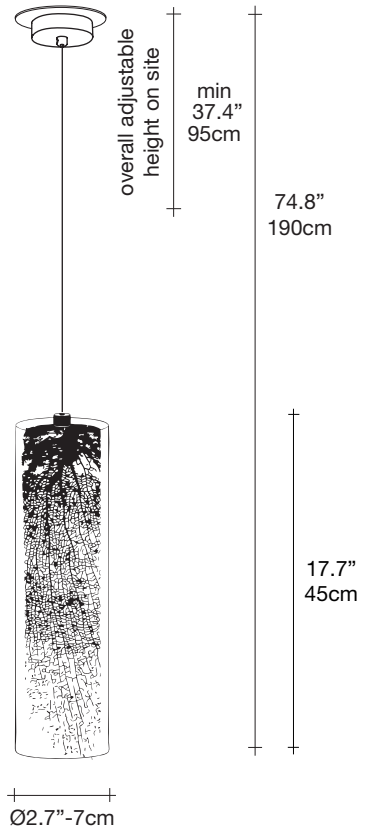

Canopy

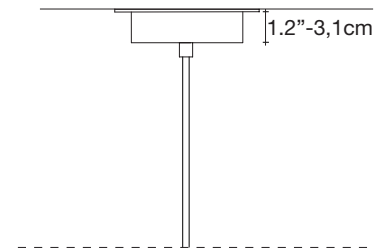
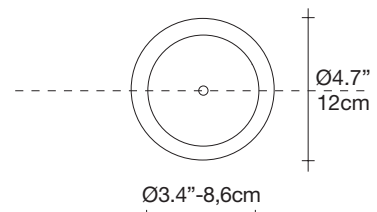

Capturing a moment in time, Frame features a metal coral leaf, enclosed inside a borosilicate glass preserving a delicate imprint of nature. Hidden inside is a single bulb which glows from within. Creating a stirring light that projects a dynamic shadow due to the permeable coral. Frame is available in white, red, gold plated or silver plated. Design Terzani Lab.

Frame, nature's, *imprint.*

design Terzani Lab
terzani.com



Product Name

Frame
large cylinder pendant light

Materials

clear



Finishes | Code

 white | clear
0Q02S E8 A9

 coral | clear
0Q02S H1 A9

 silver | clear
0Q02S G7 A9

 gold plated | clear
0Q02S L6 A9

Body

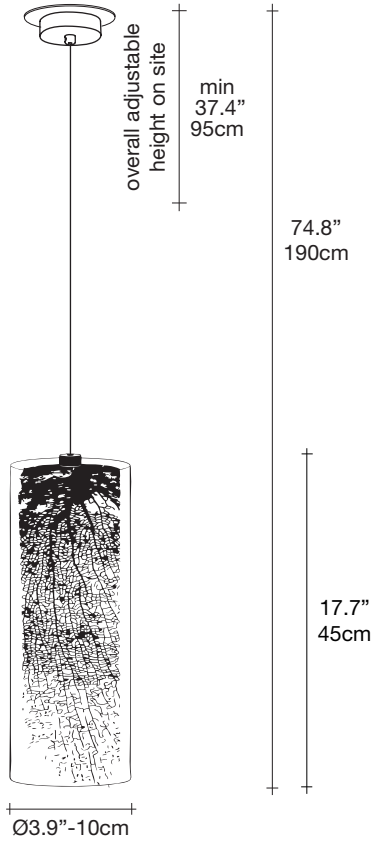

Canopy

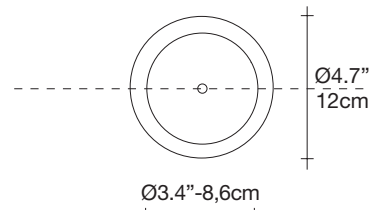

Light source

120V ~ 50/60Hz

 LED
4W E12 dimmable

dimmable options

 all systems

Capturing a moment in time, Frame features a metal coral leaf, enclosed inside a borosilicate glass preserving a delicate imprint of nature. Hidden inside is a single bulb which glows from within. Creating a stirring light that projects a dynamic shadow due to the permeable coral. Frame is available in white, red, gold plated or silver plated. Design Terzani Lab.

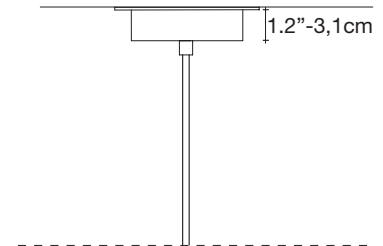

Frame, nature's, *imprint.*

design Terzani Lab
terzani.com



Product Name

Frame
cone pendant light

Materials

clear



Finishes | Code

-  white | clear
0Q03S E8 A9
-  coral | clear
0Q03S H1 A9
-  silver | clear
0Q03S G7 A9
-  gold plated | clear
0Q03S L6 A9

Body

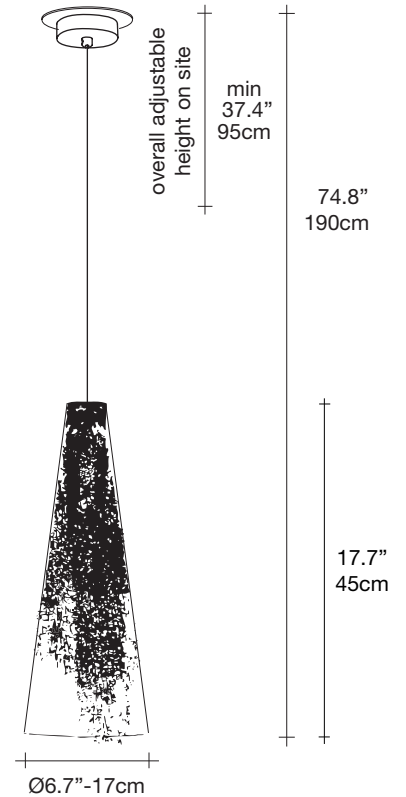

Light source

120V ~ 50/60Hz



dimmable options

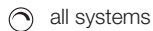

Canopy

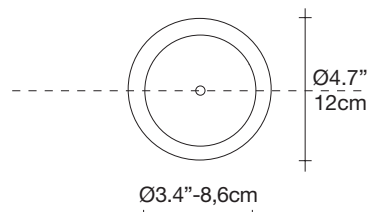

Capturing a moment in time, Frame features a metal coral leaf, enclosed inside a borosilicate glass preserving a delicate imprint of nature. Hidden inside is a single bulb which glows from within. Creating a stirring light that projects a dynamic shadow due to the permeable coral. Frame is available in white, red, gold plated or silver plated. Design Terzani Lab.

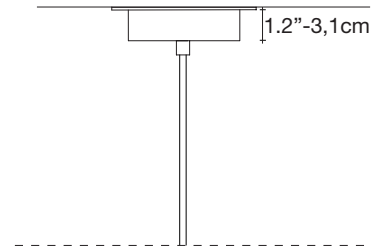

Frame, nature's, *imprint.*

design Terzani Lab
terzani.com



Product Name
Frame
wall sconce

Materials
clear



Finishes | Code

-  white | clear
0Q04A E8 A9
-  coral | clear
0Q04A H1 A9
-  silver | clear
0Q04A G7 A9
-  gold plated | clear
0Q04A L6 A9

Body

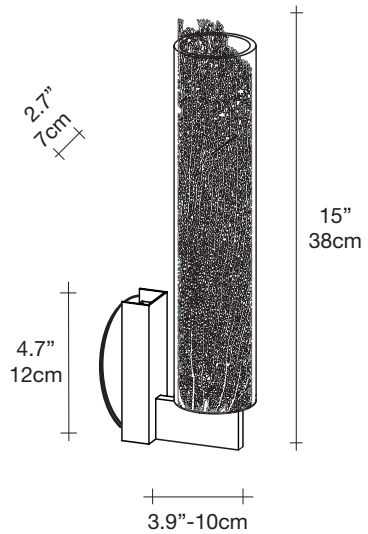

Light source
120V ~ 50/60Hz



dimnable options

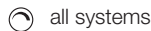

Canopy

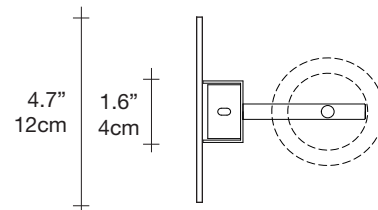
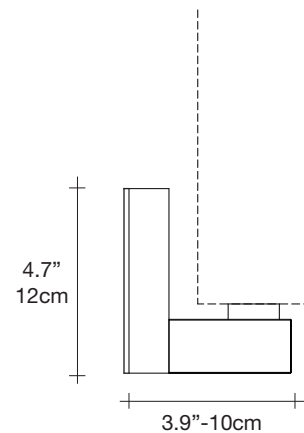

Capturing a moment in time, Frame features a metal coral leaf, enclosed inside a borosilicate glass preserving a delicate imprint of nature. Hidden inside is a single bulb which glows from within. Creating a stirring light that projects a dynamic shadow due to the permeable coral. Frame is available in white, red, gold plated or silver plated. Design Terzani Lab.