

Safety & Installation Instructions

v1.3-11.19

Prismatic Pendant Lights

Instruction Manual

ENG WARNING – RISK OF FIRE AND ELECTRIC SHOCK. THIS PRODUCT IS BEST INSTALLED BY A QUALIFIED ELECTRICIAN.
INSTALL IN ACCORDANCE WITH CURRENT NEC WIRING REGULATIONS.
SUITABLE FOR DRY LOCATIONS ONLY
THE FITTING MUST BE GROUNDED. TURN OFF POWER AT THE MAIN FUSE BEFORE COMMENCING INSTALLATION.

FR ATTENTION – RISQUE D'INCENDIE, RISQUE DE CHOC.
CE PRODUIT DOIT ÊTRE INSTALLÉ SELON LE CODE D'INSTALLATION PERTINENT, PAR UNE PERSONNE QUI CONNAÎT BIEN LE PRODUIT ET SON FONCTIONNEMENT AINSI QUE LES RISQUES INHÉRENTS.
POUR EMBLACEMENTS SECS SEULEMENT
L'APPAREIL DOIT ÊTRE MIS À LA TERRE. COUPEZ LE FUSIBLE PRINCIPAL AVANT DE COMMENCER L'INSTALLATION.

1. Prepare the fitting for installation- consulting the instructions and diagrams on the inside page. Once desired drop of pendant is established, the cable length may be shortened. If cable is desired length already, then skip to instruction point number 3.
2. To shorten cable:-
 - a. Establish required length of cable (ensuring there is some slack) before using wire cutters to cut.
 - b. Remove the outer insulation from the last 6" of the end of the cable, then remove the last 1/4" of inner sleeving from both cables to expose the wire.
 - c. Make sure that when stripping the outer cable no damage occurs to the interior cable.
3. This fitting should be installed on a 4" junction box (not supplied).
4. Open your existing junction box (if you do not have one in the desired position you will need to get an electrician to install one). If removing an existing fitting first, note all wiring connections: record which of the house wires is connected to the live, neutral and earth (ground) terminals.
5. Attach the fixing plate to your junction box using the two existing bolts.
6. In your junction box there should be two supply wires and one ground wire. Connect your new lamp to the electrical supply using UL approved wire nuts. Connect the live (hot) black wire from the power supply to the black conductor on the luminaire cable, then the white (neutral) wire to the white conductor on the luminaire cable and bare copper or green/yellow ground wire to the ground terminal or green/yellow wire connected to the fitting.

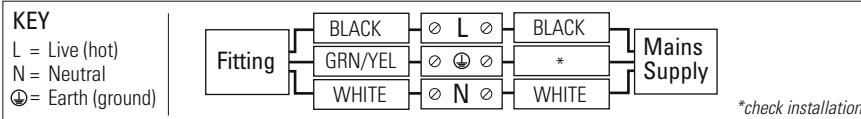

7. Support the fitting so that no strain is applied to the wiring when making the electrical connections. If necessary get a colleague to help.
8. See hanging instructions inside to complete the installation.
9. Fit the correct type and wattage of lamp (or less). Be careful not to overtighten the lamp.
10. Switch on at the fuse-board. Your light fitting is now ready for use.

Other Important Information

Switch off at mains before changing lamp(s). Never fit a lamp of greater wattage than recommended. Ensure children do not play with the light fitting. Dispose of old lamps carefully. Never leave a fitting without a lamp in position (or someone can accidentally touch the contacts). Adjust fitting only when power to the fitting is off and has been left to cool. If the electrical flex or electrical components become damaged at any point, power to the fitting should be disconnected immediately and not operated until the damaged parts are fixed/replaced. For use in dry, indoor environment only. Ensure the fitting does not come into contact with any liquids.

Cleaning and Maintenance

Metal finishes should only be cleaned with a soft, dry cloth. Do not use polishes or abrasives. Bone china can be cleaned using a soft damp cloth or with a diluted mild detergent (non-abrasive). Switch off power to the fitting before cleaning.

Established in 1990, Original BTC manufactures relaxed, familiar lighting for traditional and contemporary homes. All products are hand-assembled in Oxford from high quality components, produced in the UK.

ORIGINALBTC.COM
+44 (0)1993 882 251

UNIT 21 / 22 AVENUE ONE, STATION LANE, WITNEY, OX28 4XZ, ENGLAND

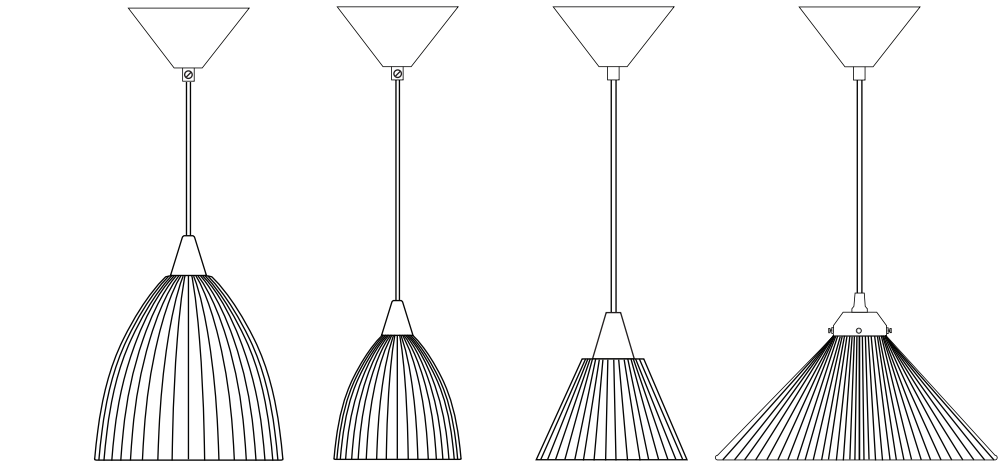

Prismatic Large
US-FP482N

Prismatic Small
US-FP481N

Circus Prismatic
US-FP309N

Coolie Prismatic
US-FP300N

ORIGINAL BTC
BRITISH LIGHTING MANUFACTURERS
LONDON - NEW YORK - PARIS





Prismatic Pendant Light

| 120V ac 60Hz | IP20 |

US-FP309N Circus Prismatic Pendant Light
US-FP300N Coolie Prismatic Pendant Light

US-FP481N Prismatic Small Pendant Light
US-FP482N Prismatic Large Pendant Light

LAMP GUIDANCE			WATTAGE**	
BASE	SHAPE	TYPE*	FP309, FP481	FP300, FP482
 E26	 A  BALL	INCANDESCENT ✓ CFL ✓ ECO-HALOGEN ✗ LED ✓	60W MAX 15W n/a 12W	100W MAX 20W n/a 18W

* Warm white (2700k) low energy lamps recommended.
** Wattage value provided as a guide to suitable lamps. Lower wattage than stated may be used.

Contents

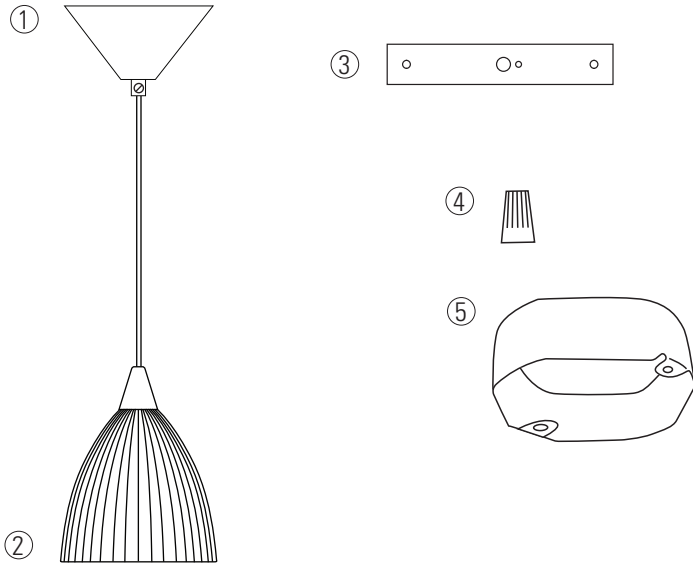

Contents

- 1 - Ceiling Rose
- 2 - Shade
- 3 - Bracket

Tools/Hardware Required

- Screwdriver
- Wire Nuts (4)
- Junction Box (5)

Installation Diagram

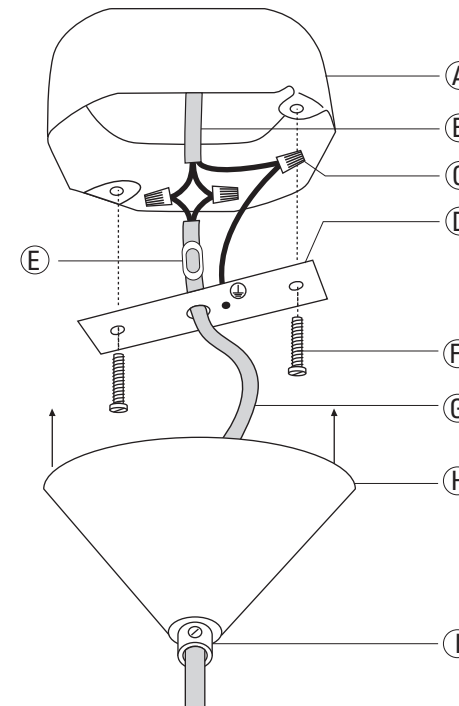

Key

- A Junction Box*
- B Main Supply
- C Wire Nuts*
- D Mounting Bracket
- E Cord Restraint
- F Junction Box Screws*
- G Luminaire Cable
- H Ceiling Rose
- I Cord Grip
- *not supplied

Hanging Instructions

Refer to diagram above.

STEP 1

Determine the required drop of the fitting and adjust luminaire cable (G) length as necessary. Follow point 2 overleaf.

STEP 2

Screw the mounting bracket (D) to the junction box using existing screws.

STEP 3

Make connection to the mains supply (follow point 5 overleaf), using suitable wire nuts.

STEP 4

The ceiling rose can now be pushed up over the bracket and the connection: Loosen the screw on the cord grip (I) before pushing the ceiling rose up so that it sits flush against the ceiling, then tighten the grub screw to hold the ceiling rose in position. Do not overtighten grub screw.

PLEASE READ THE INSTRUCTIONS ON THE REVERSE BEFORE YOU BEGIN INSTALLING YOUR LIGHT