

Instruction Manual

ENG WARNING – RISK OF FIRE AND ELECTRIC SHOCK.

SUITABLE FOR DRY LOCATIONS ONLY

FR ATTENTION – RISQUE D'INCENDIE, RISQUE DE CHOC.

POUR EMPLACEMENTS SECS SEULEMENT

These instructions are provided for your safety in order to prevent the risk of Fire, Electric shock or Injury. Please retain for future reference. When fitting is in operation, some parts will become hot; take care when using/handling.

- Ensure the lamp type and max wattage is followed- do not exceed. Take care not to overtighten lamp.
- Do not touch the lamp (bulb) or lamp holder while in operation, as both become very hot.
- Turn off and unplug fitting, leaving lamp to cool before changing lamp. Dispose of old lamps carefully.
- Never leave a fitting without a lamp in position.
- Keep light fitting away from combustible materials such as soft furnishings.
- Ensure children do not play with the light fitting.
- Ensure the light is positioned on a solid, level and non-slip surface and make sure the position of the cable does not pose a trip hazard.
- If the electrical flex or electrical components become damaged at any point, the fitting must be unplugged from the power supply immediately and not operated until the damaged parts are fixed/replaced.
- For use in a dry, indoor environment only. Ensure the fitting does not come into contact with any liquids.

Cleaning and Maintenance

Metal finishes should only be cleaned with a soft, dry cloth. Do not use polishes or abrasives. Glass can be cleaned using a soft damp cloth with a mild detergent or suitable glass cleaner if necessary. Switch off power to the fitting before cleaning. Spare parts are available for this product, please see contact details on the reverse.

Established in 1990, Original BTC manufactures relaxed, familiar lighting for traditional and contemporary homes.

All products are hand-assembled in Oxford from high quality components, produced in the UK.

ORIGINALBTC.COM
+44 (0)1993 882 251
UNIT 21 / 22 AVENUE ONE, STATION LANE, WITNEY, OX28 4XZ, ENGLAND

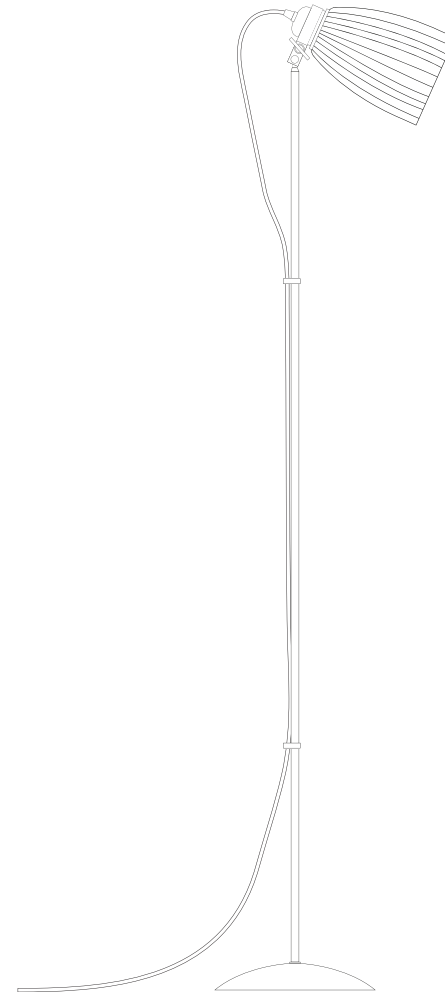

Primo Floor Light
US-FF463N

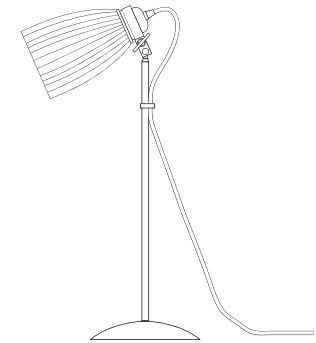

Primo Table Light
US-FT311

ORIGINAL BTC
BRITISH LIGHTING MANUFACTURERS
LONDON - NEW YORK - PARIS



Primo Table & Floor



| 120V ac 60Hz | IP20 |

US-FF463N

Primo Floor Light

US-FT311

Primo Table Light

LAMP GUIDANCE				
BASE	SHAPE	TYPE*	WATTAGE**	
 E26	 A  BALL	INCANDESCENT	✓	40W MAX
		CFL	✓	11W
		ECO-HALOGEN	✗	n/a
		LED	✓	7W

* Warm white (2700k) low energy lamps recommended.
 ** Wattage value provided as a guide to suitable lamps. Lower wattage than stated may be used.

Contents

- A Shade/Stem/Cable Assembly
- B Base*

**This will be detached from stem in floor version*

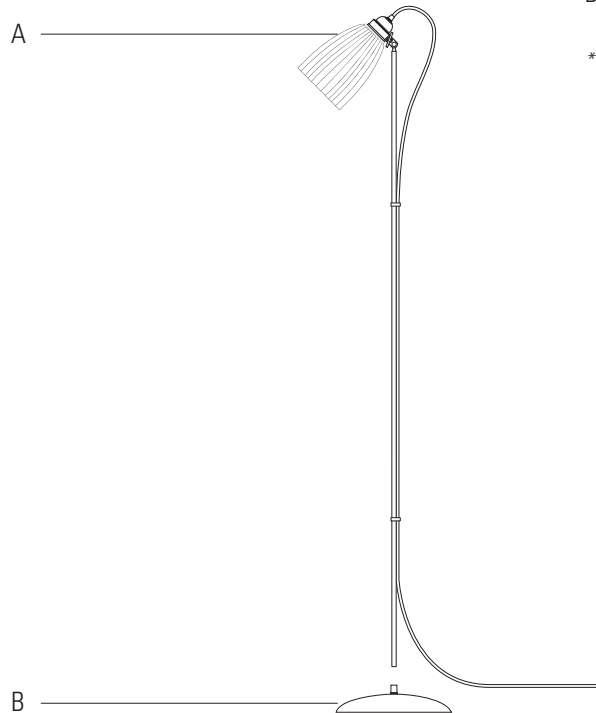

Assembling Base

- A Stem
- B Thread
- C Coupler
- D Base

STEP 1

Place base on a level floor (non-slip surfaces work best during assembly).

STEP 2

Support the stem and shade with both hands, then insert the thread into the coupler on the base. Screw the stem into the coupler until a tight, firm fit is achieved (the thread should no longer be visible).

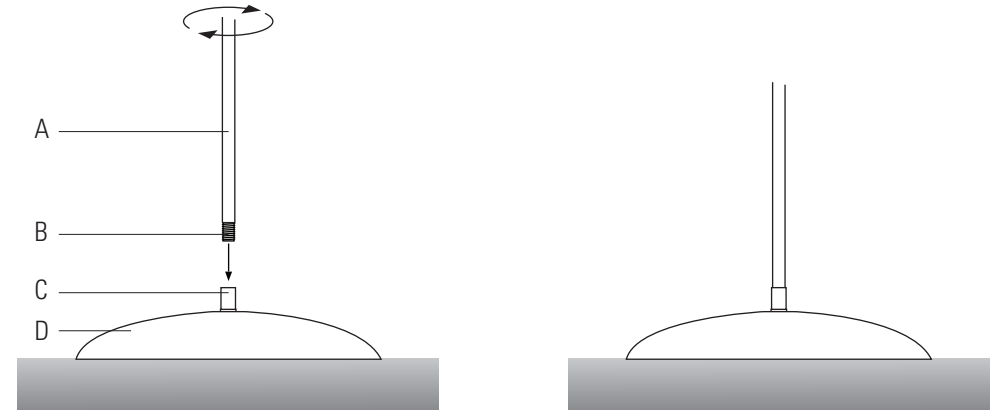

Adjusting Shade

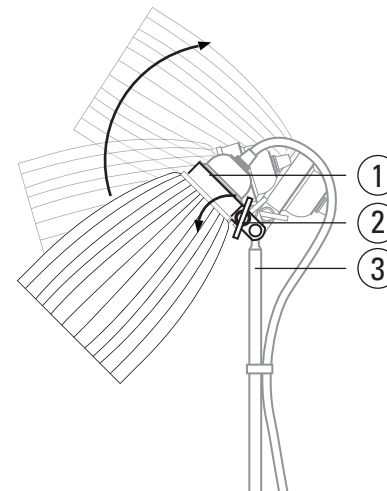

- With one hand supporting the shade, gently loosen the clamp handle (2). One quarter-turn, in an anti-clockwise direction should be sufficient.
- The shade can then be moved into desired position, ensuring the clamp remains attached to the stem, but without applying excessive force to the washers on the inside of the clamp. Ensure the shade is still supported whilst adjusting position.
- Secure in place by gently tightening clamp handle, **taking care NOT to overtighten**, as this can damage the clamp.
- Do not adjust the position of the shade without loosening the clamp first, as this will damage the washers.