

Safety & Installation Instructions

v1.2-11.18

These instructions are provided for your safety in order to prevent the risk of Fire, Electric shock or Injury. It is vitally important that they are read in their entirety before installing your fitting. Please retain for future reference.

ENG WARNING – RISK OF FIRE AND ELECTRIC SHOCK. THIS PRODUCT IS BEST INSTALLED BY A QUALIFIED ELECTRICIAN. INSTALL IN ACCORDANCE WITH CURRENT NEC WIRING REGULATIONS.

DRY LOCATIONS ONLY

THE FITTING MUST BE GROUNDED. TURN OFF POWER AT THE MAIN FUSE BEFORE COMMENCING INSTALLATION.

FR ATTENTION – RISQUE D'INCENDIE, RISQUE DE CHOC.

CE PRODUIT DOIT ÊTRE INSTALLÉ SELON LE CODE D'INSTALLATION PERTINENT, PAR UNE PERSONNE QUI CONNAÎT BIEN LE PRODUIT ET SON FONCTIONNEMENT AINSI QUE LES RISQUES INHÉRENTS.

POUR EMPLACEMENTS SECS SEULEMENT

L'APPAREIL DOIT ÊTRE MIS À LA TERRE. COUPEZ LE FUSIBLE PRINCIPAL AVANT DE COMMENCER L'INSTALLATION.

1. Prepare the fitting for installation- consulting the instructions and diagrams on the inside page. Once desired drop of pendant is established, the cable (marked (H) in the diagram inside) length, may be shortened. If cable is desired length already, then skip to instruction point number 3.
2. To shorten cable:
 - a. Establish required length of cable (ensuring there is some slack) before using wire cutters to cut.
 - b. Remove the outer insulation from the last 6" of the end of the cable, then remove the last 1/4" of inner sleeving from both cables to expose the wire.
 - c. Make sure that when stripping the outer cable no damage occurs to the interior cable.Chain can be shortened by opening up a link using a chain tool/pliers at the specified length and removing the excess.
3. This fitting should be installed on a 4" junction box (not supplied).
4. Open your existing junction box (if you do not have one in the desired position you will need to get an electrician to install one). If removing an existing fitting first, note all wiring connections: record which of the house wires is connected to the live, neutral and earth (ground) terminals.
5. Attach the fixing plate to your junction box using the two existing bolts.
6. In your junction box there should be two supply wires and one ground wire. Connect your new lamp to the electrical supply using UL approved wire nuts. Connect the live (hot) black wire from the power supply to the black conductor on the luminaire cable, then the white (neutral) wire to the white conductor on the luminaire cable and bare copper or green/yellow ground wire to the ground terminal or green/yellow wire connected to the fitting. Support the fitting so that no strain is applied to the wiring when making the electrical connections. If necessary get a colleague to help.

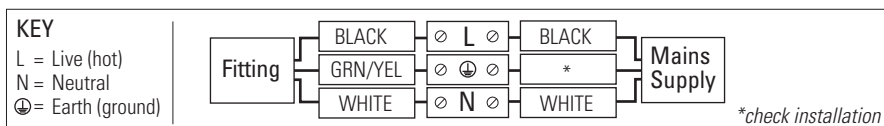

7. See hanging instructions inside to mount your fitting to the junction box (attaching to fixing plate) and complete the installation.
8. Fit the correct type and wattage of lamp (or less). Be careful not to overtighten the lamp.
9. Switch on at the fuse-board. Your light fitting is now ready for use.

Other Important Information

Switch off at mains before changing lamp(s). Never fit a lamp of greater wattage than recommended. Ensure children do not play with the light fitting. Dispose of old lamps carefully. Never leave a fitting without a lamp in position (or someone can accidentally touch the contacts). If the electrical flex or electrical components become damaged at any point, power to the fitting should be disconnected immediately and not operated until the damaged parts are fixed/replaced. For use in dry, indoor environment only. Ensure the fitting does not come into contact with any liquids.

Cleaning and Maintenance

Metal finishes should only be cleaned with a soft, dry cloth. Do not use polishes or abrasives. Glass can be cleaned by hand, using a soft damp cloth with a diluted mild detergent (nonabrasive) or suitable glass cleaner if necessary. Switch off power to the fitting before cleaning. Spare parts are available for this product, please contact us on the details below.

Established in 1990, Original BTC manufactures relaxed, familiar lighting for traditional and contemporary homes.

All products are hand-assembled in Oxford from high quality components, produced in the UK.

ORIGINALBTC.COM

+44 (0)1993 882 251

UNIT 21 / 22 AVENUE ONE, STATION LANE, WITNEY, OX28 4XZ, ENGLAND



Glass Pendant Lights

US-DP8200 / DP8200/M

DP8165 - DP8164

Instruction Manual

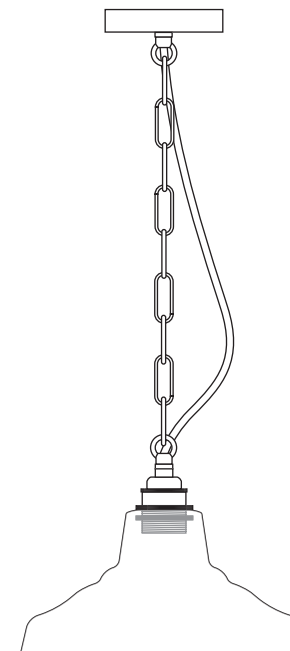

School Pendant, Size 1
US-DP8200/S

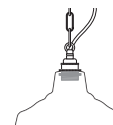

School Pendant, Size 2
US-DP8200/M

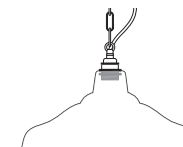

York Pendant, Size 1
US-DP8165

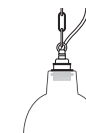

York Pendant, Size 1
US-DP8164

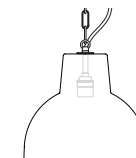



ORIGINAL BTC
BRITISH LIGHTING MANUFACTURERS
LONDON - NEW YORK - PARIS



Glass Pendants

| 120V ac 60Hz | IP20 |

US-DP8165 YorkPendant Size 1 US-DP8200/S School Pendant Size 1
 US-DP8164 York Pendant Size 2 US-DP8200/M School Pendant Size 2

LAMP GUIDANCE			
BASE	SHAPE	TYPE*	WATTAGE**
 E26	 A	 BALL	INCANDESCENT ✓
			CFL ✓
			ECO-HALOGEN ✓
			LED ✓
			60W MAX
			15W
			42W
			10W

* Warm white (2700k) low energy lamps recommended.
 ** Wattage value provided as a guide to suitable lamps. Lower wattage than stated may be used.

PLEASE READ THE INSTRUCTIONS ON THE REVERSE BEFORE YOU BEGIN INSTALLING YOUR LIGHT

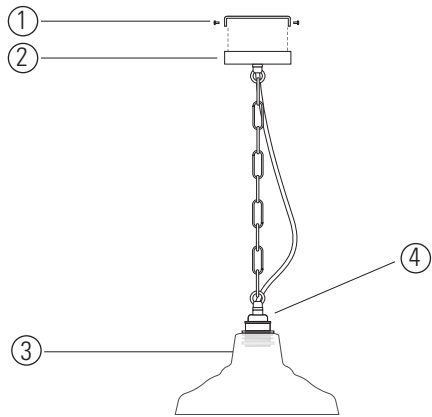

Contents

- 1 - Ceiling plate & gallery screws
- 2 - Ceiling rose
- 3 - Shade
- 4 - lampholder assembly

Required for Installation

- Screwdriver, flat-head
- Wire nuts x 3 (8)
- Junction box (9)

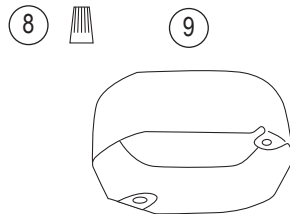

Installation Diagram

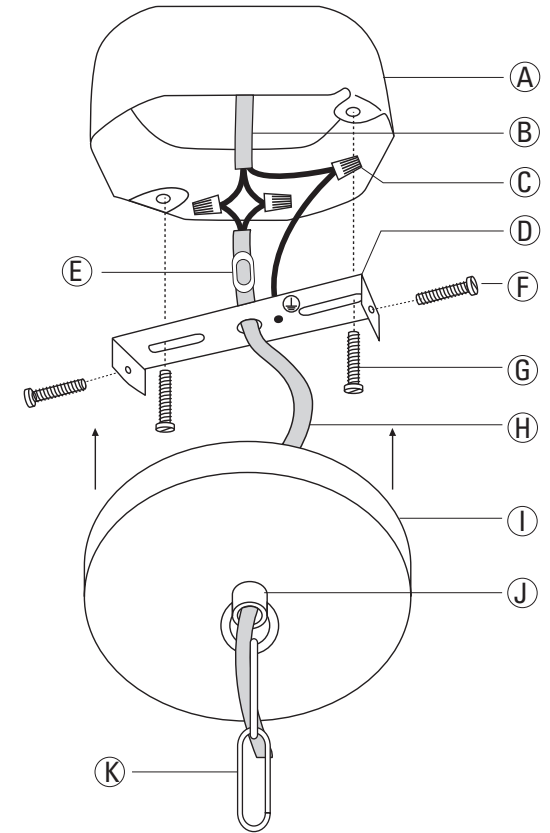

Key

- A Junction Box*
- B Main Supply
- C Wire Nuts*
- D Mounting Bracket
- E Cord Restraint
- F Side Fixing Screws
- G Junction Box Screws*
- H Luminaire Cable
- I Ceiling Rose
- J Loop
- K Chain
- *not supplied

Hanging Instructions

This product is made from glass; take extra care when handling this product during installation.

Refer to diagram above.

- 1 - Determine the required drop of the fitting and adjust luminaire cable (H) length as necessary - see point 1 overleaf. Ensure there is some slack in the cable.
- 2 - Screw the mounting bracket (D) to the junction box using existing screws.
- 3 - Make connection to the mains supply (follow instructions overleaf), using suitable wire nuts.
- 4 - Secure ceiling plate cover to mounting bracket using side fixing screws.
- 5 - The pendant can now be hung from the ceiling hook by connecting the chain. Once lamp is inserted and power is restored, your fitting will be ready for operation.