

ENG WARNING – RISK OF FIRE AND ELECTRIC SHOCK.
SUITABLE FOR DRY LOCATIONS ONLY
FR ATTENTION – RISQUE D'INCENDIE, RISQUE DE CHOC.
POUR EMPLACEMENTS SECS SEULEMENT

These instructions are provided for your safety in order to prevent the risk of Fire, Electric shock or Injury. Please retain for future reference. When fitting is in operation, some parts will become hot; take care when using/handling.

- Ensure the lamp type and max wattage is followed- do not exceed. Take care not to overtighten lamp.
- Do not touch the lamp (bulb) in operation, as it will become hot.
- Turn off and unplug fitting, leaving lamp to cool before changing lamp. Dispose of old lamps carefully.
- Adjust light fitting only when power to the fitting is off and has been left to cool.
- Never leave a fitting without a lamp in position.
- Keep light fitting away from combustible materials such as soft furnishings.
- Ensure children do not play with the light fitting.
- Ensure the light is positioned on a solid, level and non-slip surface and make sure the position of the cable does not pose a trip hazard.
- If the electrical flex or electrical components become damaged at any point, the fitting must be unplugged from the power supply immediately and not operated until the damaged parts are fixed/replaced.
- For use in a dry, indoor environment only. Ensure the fitting does not come into contact with any liquids.

Hector Table & Floor Light

Instruction Manual

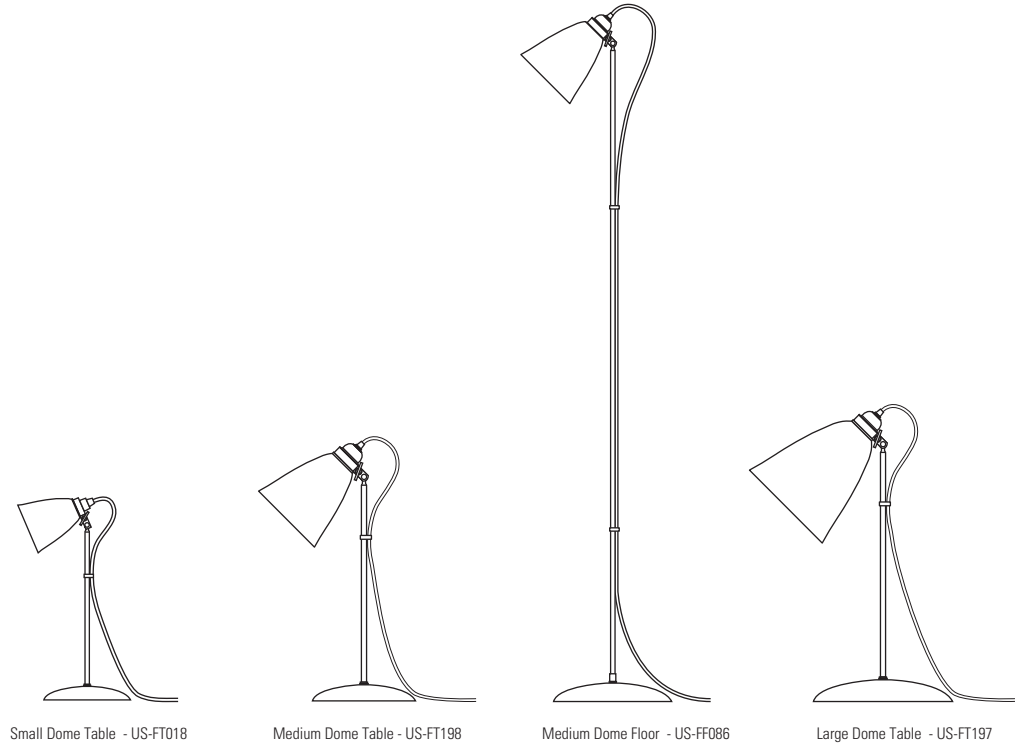

Small Dome Table - US-FT018

Medium Dome Table - US-FT198

Medium Dome Floor - US-FF086

Large Dome Table - US-FT197

Small Dome Table - US-FT018
Medium Dome Table - US-FT198
Medium Dome Floor - US-FF086

Small Pleat Table - US-FT021
Medium Pleat Table - US-FT380
Medium Pleat Floor - US-FF388

Small Flowerpot Table - US-FT155
Medium Flowerpot Table - US-FT429
Medium Flowerpot Floor - US-FF430

Small Circle Line Table - US-FT018CL
Medium Circle Line Table - US-FT198CL
Circle Line Floor - US-FF086CL

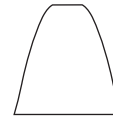

Linear Table - US-FT492LW
Linear Floor - US-FF495

21 Table - US-FT487

Metal Table - US-FT315LP
Metal Floor - US-FF426LP

Bibendum Table - US-FT491BW
Bibendum Floor - US-FF497WR

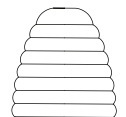
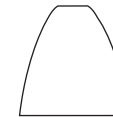
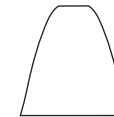

Cleaning and Maintenance

Metal finishes should only be cleaned with a soft, dry cloth. Do not use polishes or abrasives. Bone china can be cleaned using a soft damp cloth with a mild detergent if necessary. Switch off power to the fitting before cleaning. Spare parts are available for this product, please see contact details on the reverse.



Established in 1990, Original BTC manufactures relaxed, familiar lighting for traditional and contemporary homes. All products are hand-assembled in Oxford from high quality components, produced in the UK.

Hector Table & Floor Light





| 120V ac 60Hz | IP20 |

US-FT018	Small Dome Table	US-FT197	Large Dome Table
US-FT021	Small Pleat Table		
US-FT155	Small Flowerpot Table	US-FF086	Medium Dome Floor
US-ST018CL	Small Circle Line Table	US-FF388	Medium Pleat Floor
		US-FF430	Medium Flowerpot Floor
US-FT198	Medium Dome Table	US-FF086CL	Circle Line Floor
US-FT380	Medium Pleat Table	US-FF495	Linear Floor
US-FT429	Medium Flowerpot Table	US-FF426LP	Metal Floor
US-FT198CL	Medium Circle Line Table	US-FF497WR	Bibendum Floor
US-LFT492	Linear Table		
US-FT487W	21 Table		
US-FT315LP	Metal Table		
US-FT491BW	Bibendum Table		

A British design classic in translucent bone china. With its moveable shade and smart cotton braided flex, the Hector table light marries style and function. The range includes a selection of simple bone china pendants, wall lights and floor lights, with several shade varieties, including an aluminium version.

LAMP GUIDANCE			
BASE	SHAPE	TYPE*	WATTAGE**
	 	INCANDESCENT ✓ CFL ✓ ECO-HALOGEN ✗ LED ✓	40W MAX 11W n/a 7W

* Warm white (2700k) low energy lamps recommended.
** Wattage value provided as a guide to suitable lamps. Lower wattage than stated may be used.

LAMP GUIDANCE (Hector Small ONLY)			
BASE	SHAPE*	TYPE**	WATTAGE***
	  	INCANDESCENT (R50 only) ✓ CFL ✓ ECO-HALOGEN ✗ LED ✓	40W 9W n/a 7W

* Use low energy CFL or LED candle/ball lamp for a combination of ambient and low level task lighting or R50 lamp if high level task illumination required.
** Warm white (2700k) low energy lamps recommended.
*** Wattage value provided as a guide to suitable lamps. Lower wattage than stated may be used.

Assembling Base

A Stem C Coupler
B Thread D Base

STEP 1

Place base on a level floor (non-slip surfaces work best during assembly).

STEP 2

Support the stem and shade with both hands, then insert the thread into the coupler on the base. Screw the stem into the coupler until a tight, firm fit is achieved (the thread should no longer be visible).

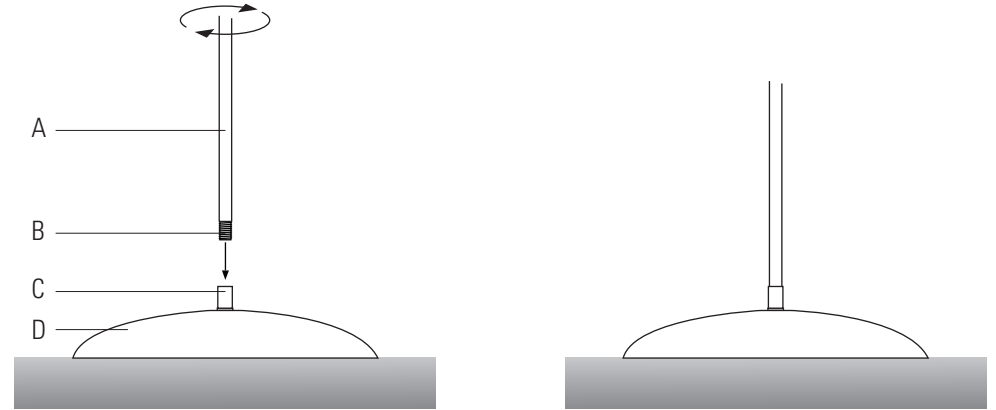

Adjusting Shade

- With one hand supporting the shade, gently loosen the clamp handle (2). One quarter-turn, in an anti-clockwise direction should be sufficient.
- The shade can then be moved into desired position, ensuring the clamp remains attached to the stem, but without applying excessive force to the washers on the inside of the clamp. Ensure the shade is still supported whilst adjusting position.
- Secure in place by gently tightening clamp handle, **taking care NOT to overtighten**, as this can damage the clamp.
- Do not adjust the position of the shade without loosening the clamp first, as this will damage the washers.

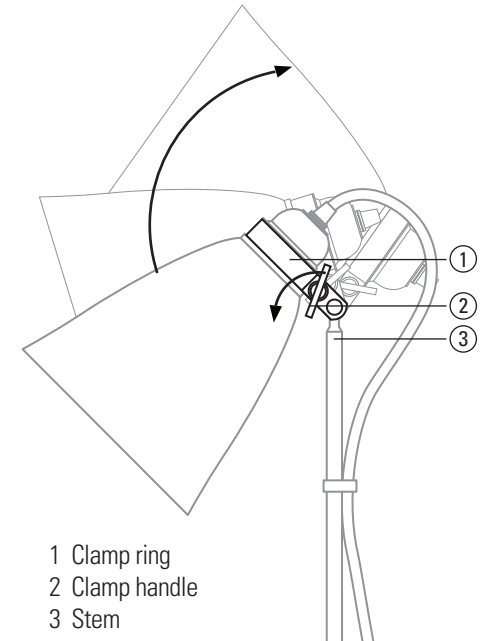

1 Clamp ring
2 Clamp handle
3 Stem