

# GABRIEL SCOTT

est 2012



## LUNA Kaleido 1 Tier Chandelier

Inspired by a lunar halo, the LUNA is a highly customizable modular light fixture which grows in every direction as its assembly system stems horizontally or vertically. Stacking color upon color of various mouth-blown glass shapes, the series has been designed to offer infinite interpretations of tone, shape and refracted light.

The new Kaleido Collection plays with texture, color and shape to distort light and create magical optical illusions when looking through the glass. Combining soft iridescent colors with patterned textures and delicately shaped glass beads, the Kaleido Collection effortlessly brings together smoked gray, smoked bronze, opaque pink, opaque blue, opaque white and clear colored glass with six new textures and shapes.

All Gabriel Scott pieces are handmade in Canada.

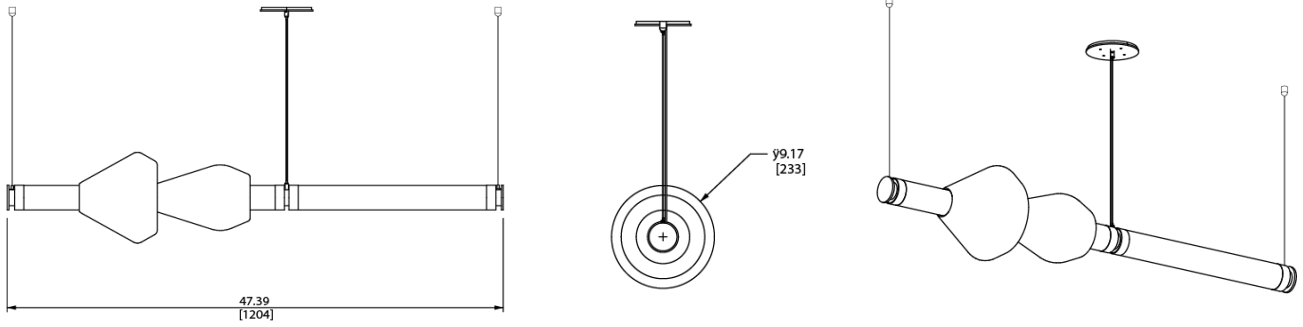

## SPECIFICATIONS

### Standard Finishes:

Metal: Blackened Steel, Satin Brass, Satin Copper, Satin Bronze or Satin Nickel

Glass Textures: Twisted, Bubbled, Ribbed, Gridded, Dotted & Smoothed

Glass Colours: Smoked Bronze, Smoked Gray, Clear, Opaque Blue, Opaque Pink & Opaque White

### Specifications:

Dimensions: 47.39" x 9.17" + Drop

120.37cm x 23cm + Drop

Weight: 50 lbs

Light source: 24V 6 Watt LED (included)

Standard lead time: 12-14 weeks

### Cables & Canopies:

Standard Cable Length: 96" Drop, adjustable upon installation

(increased cable-lengths available upon request)

Standard Canopy: 5"

Deep Canopy: Dimensions on request.

Custom finishes available upon inquiry.

Made and assembled in Canada. Item is UL & CE listed.



FILE#: E488971  
FILE#: E503097

## STANDARD FINISHES

### Metal:

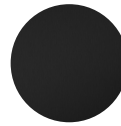

Blackened Steel



Satin Brass



Satin Copper



Satin Bronze



Satin Nickel

### Glass Colors:



Smoked Bronze



Smoked Gray



Clear



Opaque Blue



Opaque Pink



Opaque White

### Glass Textures:



Twisted

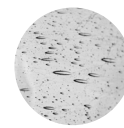

Bubbled

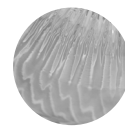

Ribbed

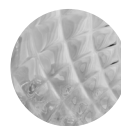

Gridded

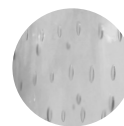

Dotted



Smoothed

LUNA Kaleido 1 Tier B - With Cygnus & Lyra Glass Beads

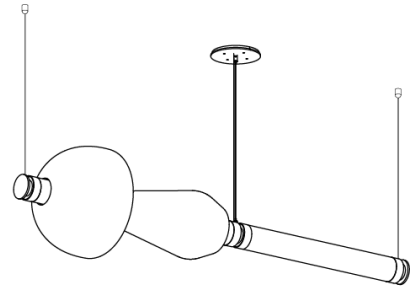
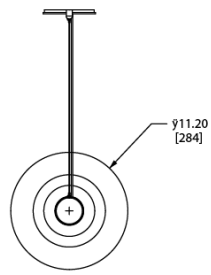
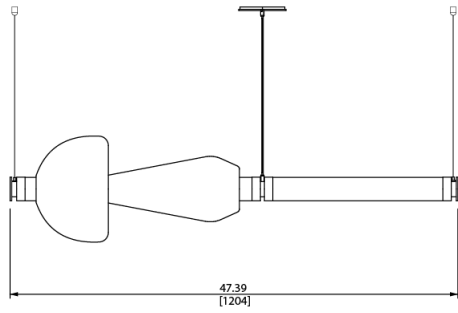

LUNA Kaleido 1 Tier C - With a Dorado Glass Bead

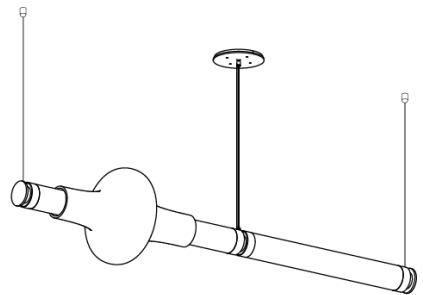
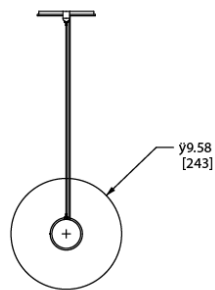
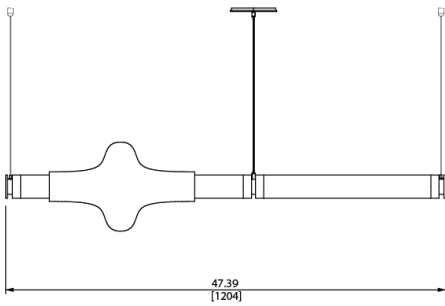



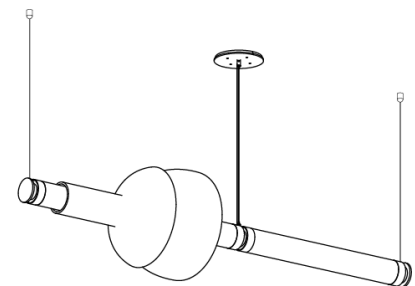
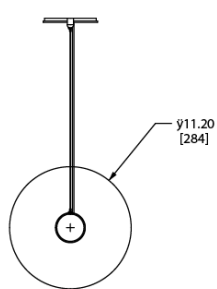
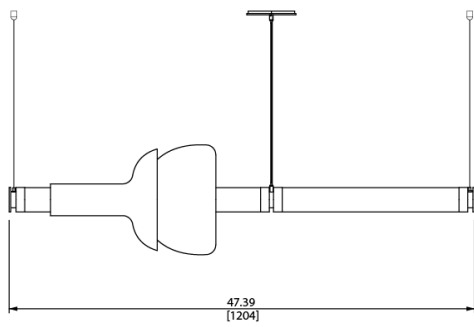



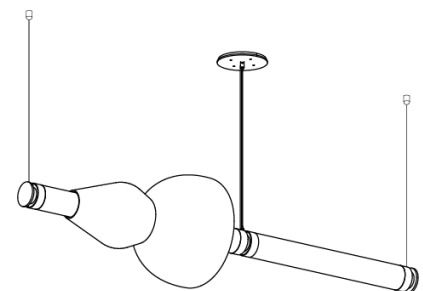
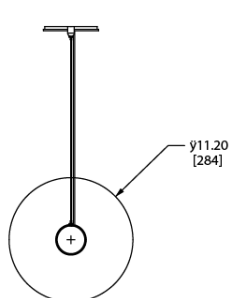
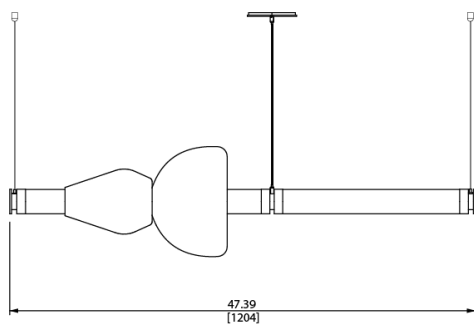



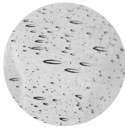
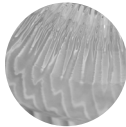
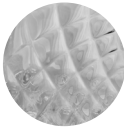

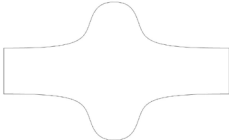

















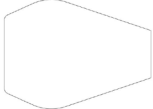

































LUNA Kaleido 1 Tier D - With Carina & Cygnus Glass Beads



LUNA Kaleido 1 Tier E - With Aras & Cygnus Glass Beads



# LUNA Kaleido - Finishes Selection

	 Twisted	 Bubbled	 Ribbed	 Gridded	 Dotted	 Smoothed
 <b>Dorado</b> 15.6" X DIA. 9.5"	  	  			 	 
 <b>Lyra</b> 13.9" X DIA. 6.9"	  	 	 	 		
 <b>Ara</b> 8.9" X DIA. 6.6"	  	 	 	 		
 <b>Cygnus</b> 7.6" X DIA. 11.2"	    	  				  
 <b>Orion</b> 7.5" X DIA. 9.2"	    	 	 			
 <b>Carina</b> 10.9" X DIA. 10.4"	 					 

Note: Every individual glass bead is hand-blown to order. With any artisanal process, there is likely to be variation in the finish which makes each piece unique and special. Every bead goes through a rigorous inspection process prior to being delivered to ensure they're up to the high standard Gabriel Scott expects.