

TREVI 6 PENDANT

Installation Guide

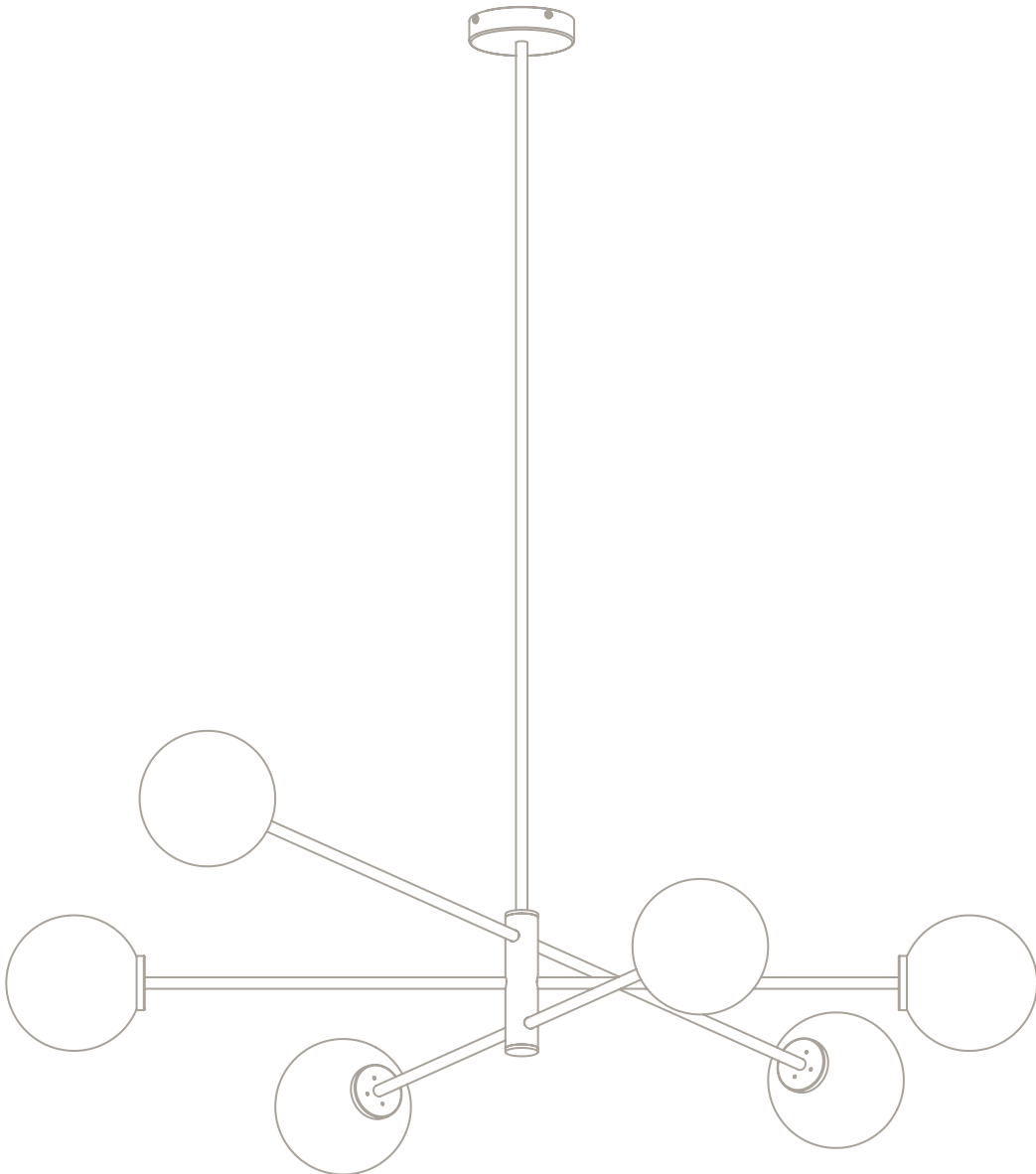

!

Please handle with care and wear gloves at all times during assembly and installation to avoid damaging components.

TECHNICAL

Bulb Holder
 240v - 6 x E14
 120v - 6 x E12
 (bulbs not supplied)

Wattage
 25w max (or 2.5w LED 2700k)

Weight
 10kg (22lbs)

PARTS & COMPONENTS

- A. 1 x Mounting plate, 4 x M4x12 screws
- B. 1 x Ceiling rose and drop rod
- C. 6 x 150mm glass shade
- D. 1 x Trevi 6 body

A.



B.

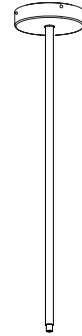

C.

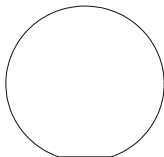

D.

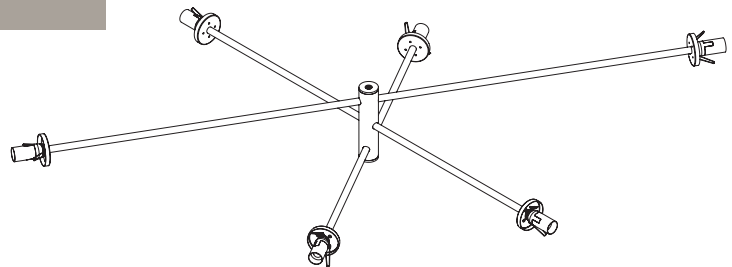

- All nuts and bolts required for assembling the light are included.



BEFORE INSTALLATION

- Check that you have all components before starting the installation.
 - Installation must be carried out by a qualified electrician.
 - A minimum of two people is required to install a pendant light.
- Check that the ceiling or wall fixings are suitable and strong enough to support the weight of the light fixture.
 - You will need the below specific tools for a successful installation.

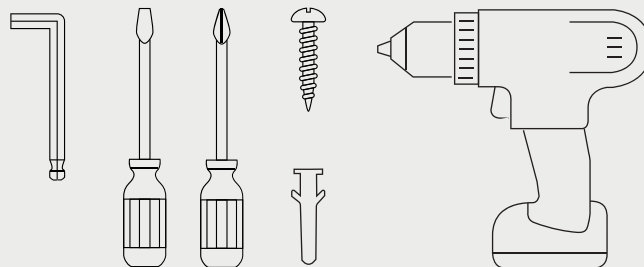

HEIGHT ADJUSTMENT INSTRUCTIONS

Before attaching the drop rod to the body of the light, calculate the required total drop from ceiling to bottom of pendant. If any height adjustment is required, follow the steps below:

1. Separate the brass tube and the internal threaded tube from the ceiling rose cover by unscrewing the bolt.

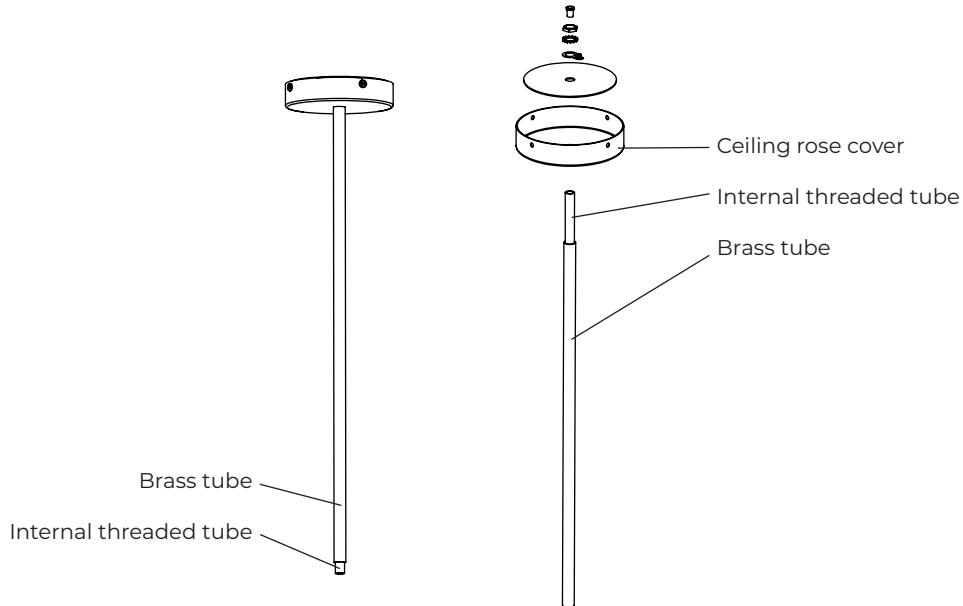

2. Measure the length the drop rod needs to be.
3. Cut the brass tube to this length using a hacksaw or similar tool.
4. Cut the same length from the internal threaded tube.

NOTE: Internal threaded tube must always be longer than the brass tube.

5. Once the brass tube and internal threaded tube are cut to correct lengths, slide the brass tube over the internal threaded tube and attach them back to the ceiling rose cover by using components provided.

6. Once satisfied with the fit, secure bolts and all-thread with Loc-tite or similar adhesive.

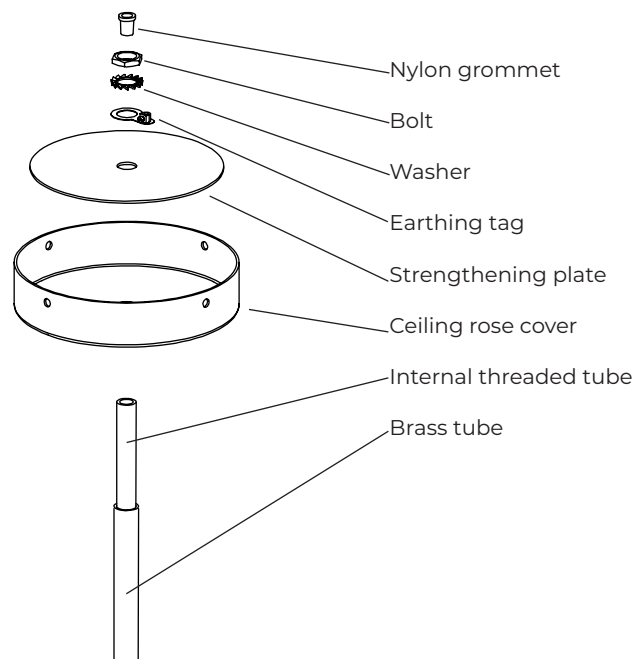

1. Fix the mounting plate to the ceiling. Ensure that suitable screws are being used for the surface that you are mounting to (not supplied).

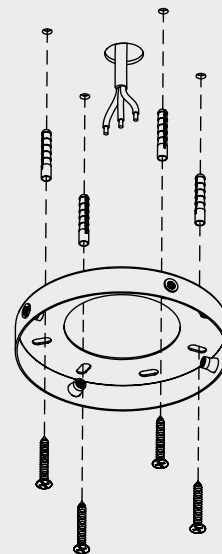

1. 120v
US Fix the mounting plate to the junction box using suitable screws (not supplied).

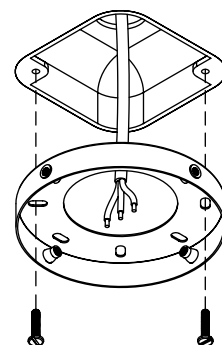

2. Feed the power cable from the drop rod into the ceiling rose cover.

Screw the drop rod to the central hub of the pendant.

Note: The drop rod should be tightened into the hub using a spanner to ensure there is no play between the parts.

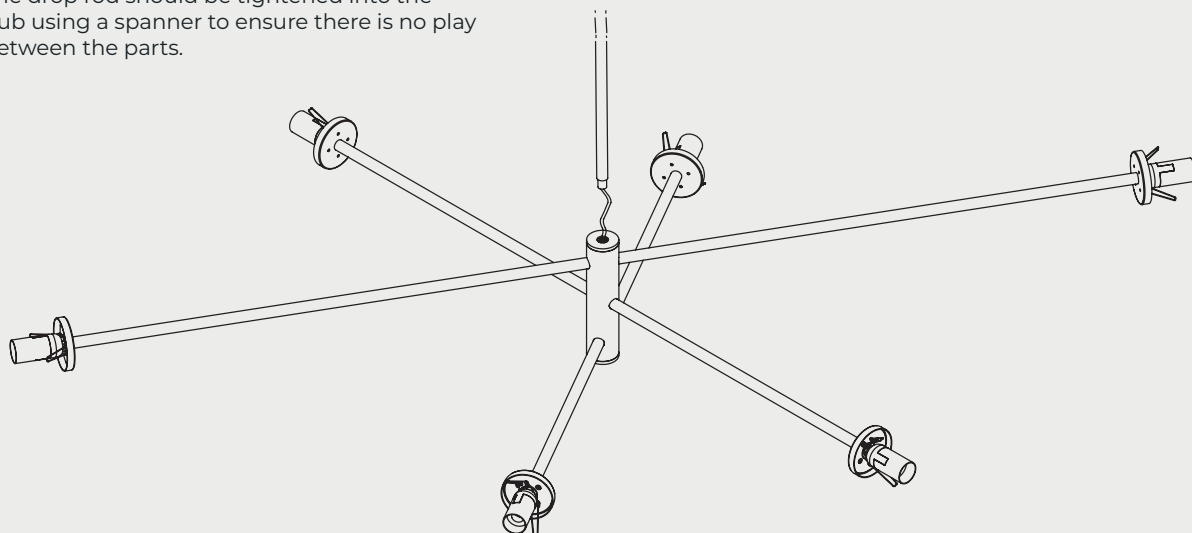

3. Raise the pendant and make the electrical connections ensuring all wires are colour matched and the pendant is earthed correctly.

Bring the ceiling rose up to the mounted plate and secure using provided screws.

Note: Ensure that the weight of the pendant is fully supported during the electrical installation.

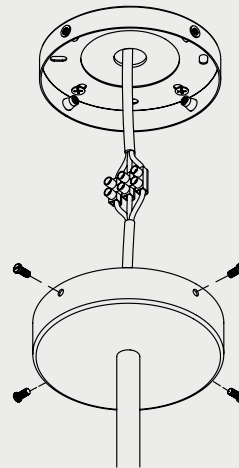

3. 120V

- US Raise the pendant and make the electrical connections inside the junction box ensuring all wires are colour matched and the pendant is earthed correctly.

Bring the ceiling rose up to the mounted plate and secure using provided screws.

Note: Ensure that the weight of the pendant is fully supported during the electrical installation.

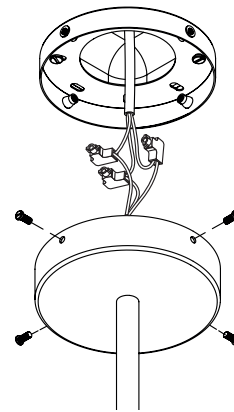

4. A. Fit the bulbs (not supplied) to the lamp-holder.

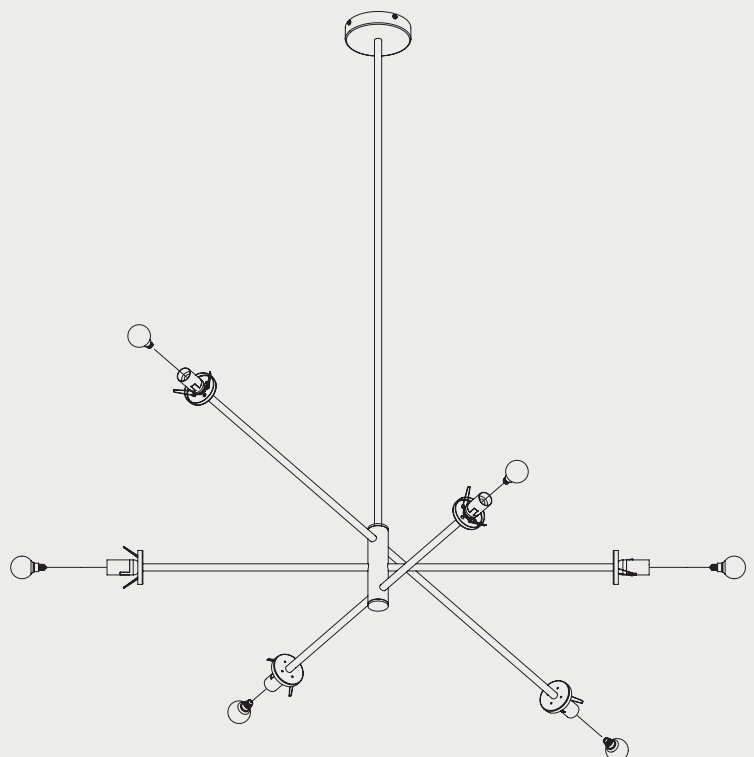

5. B. Fit the glass shades to the pendant body.

Pinch the spring clips inwards and hold, slowly feeding the glass shade over the spring clips. Do not release the glass shades too quickly.

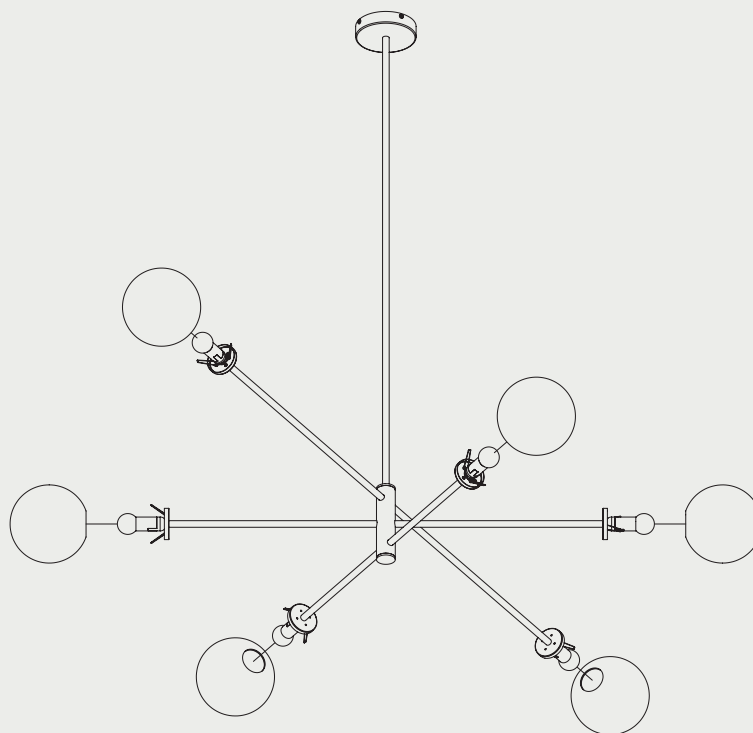
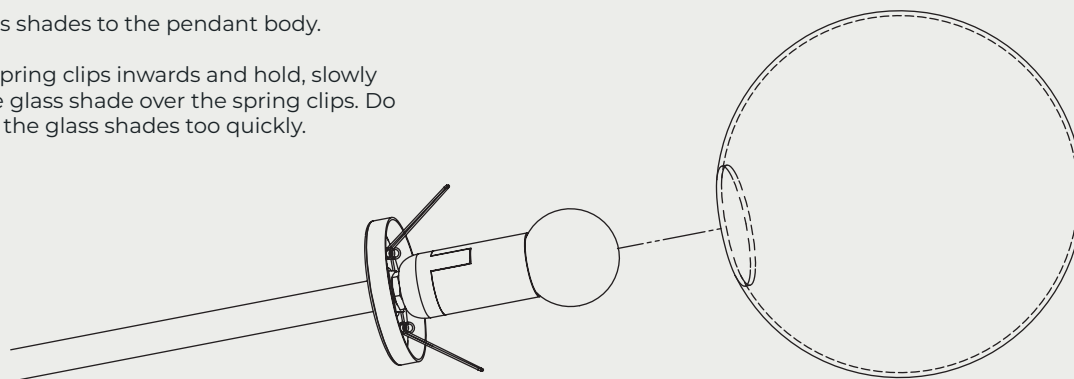

MAINTENANCE

Cleaning

Dust using a dry lint-free cloth weekly or as required

Repairs

Contact
CTO Lighting

Warranty

Please visit
[www.ctolighting.co.uk/
pages/f-a-q](http://www.ctolighting.co.uk/pages/f-a-q)
for CTO warranty policy

Certification



E492308