



Core, Eruption of Light.

design Christian Lava
terzani.com



Type |
Suspension
Materials |
Brass

Finishes | Code

-  Nickel
0P22S E7 A9
-  Black Nickel
0P22S E9 A9
-  Gold
0P22S L6 A9

Body |

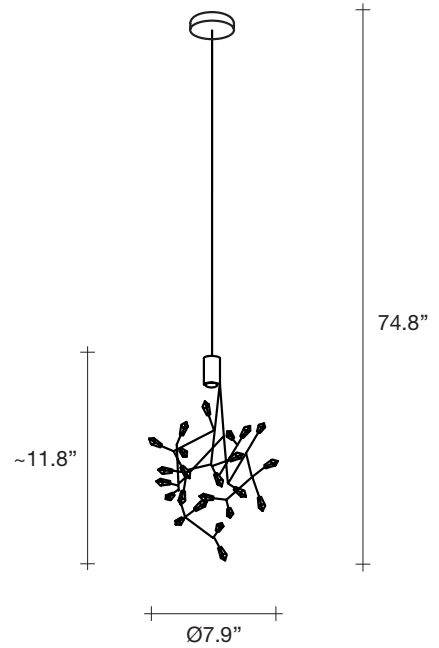

Integrated Led |
120V ~ 50/60Hz

 LED integrated
3000K 2,1W
240lm

 Not Dimmable

Canopy |

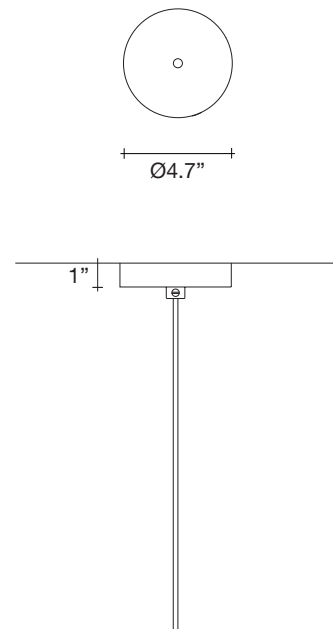

Core is reminiscent of the natural energy at the heart of our world. Like bright lava seeping through the earth's crust, vibrant spheres of faceted crystal break through the iron surface of this pendant. Forcing light to pass through this metal structure results in a powerful, vibrant exchange of forces light and shadow erupt across the room, as the LED light pours through, as the light itself emits an organic radiance. Design Christian Lava.

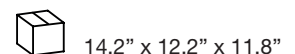

Core, Eruption of Light.



design Christian Lava
terzani.com



Type |
Suspension

Materials |
Brass

Finishes | Code

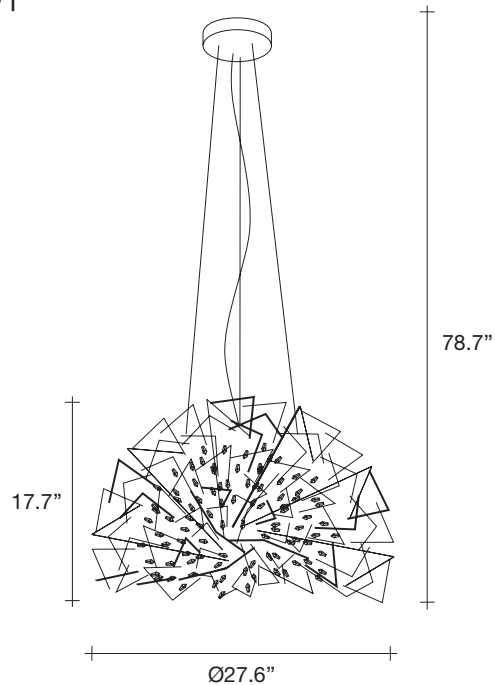

-  Nickel
OP21S E7 A9
-  Black Nickel
OP21S E9 A9
-  Gold
OP21S L6 A9

Body |



Integrated Led |

120V ~ 50/60Hz

-  COB LED integrated
18W
1640lm
-  Dimmable with 1-10V and PUSH
Dali system on request

Canopy |

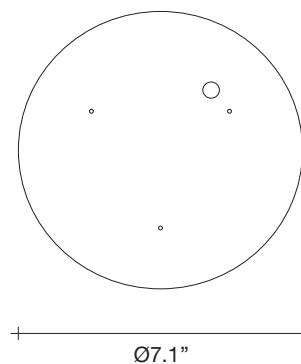

Core is reminiscent of the natural energy at the heart of our world. Like bright lava seeping through the earth's crust, vibrant spheres of faceted crystal break through the iron surface of this pendant. Forcing light to pass through this metal structure results in a powerful, vibrant exchange of forces light and shadow erupt across the room, as the LED light pours through, as the light itself emits an organic radiance. Design Christian Lava.



46.3



26.5



33" x 33" x 28.3"

Core, Eruption of Light.

design Christian Lava
terzani.com



Type |
Suspension
Materials |
Brass



Finishes | Code

-  Nickel
OP20S E7 A9
-  Black Nickel
OP20S E9 A9
-  Gold
OP20S L6 A9

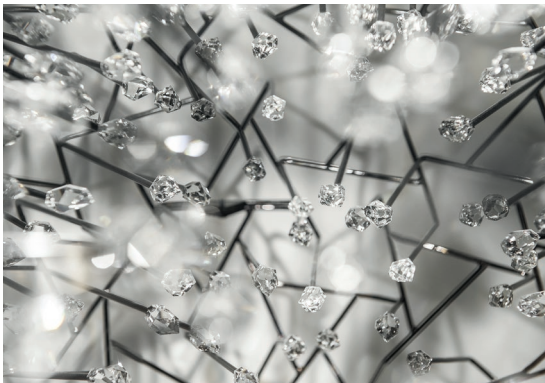
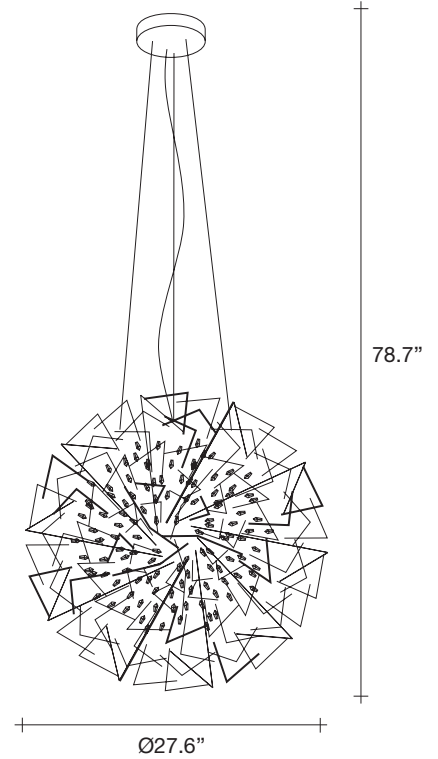
Body |



Integrated Led |
120V ~ 50/60Hz

-  COB LED integrated
18W
1640lm
-  Dimmable with 1-10V and PUSH
Dali system on request

Canopy |

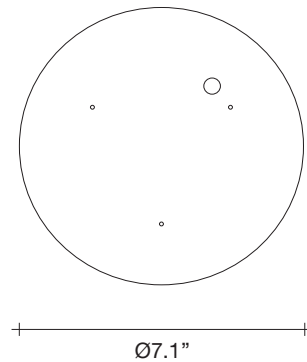

Core is reminiscent of the natural energy at the heart of our world. Like bright lava seeping through the earth's crust, vibrant spheres of faceted crystal break through the iron surface of this pendant. Forcing light to pass through this metal structure results in a powerful, vibrant exchange of forces light and shadow erupt across the room, as the LED light pours through, as the light itself emits an organic radiance. Design Christian Lava.



57.3



36.4



32.7" x 30.7" x 37.4"

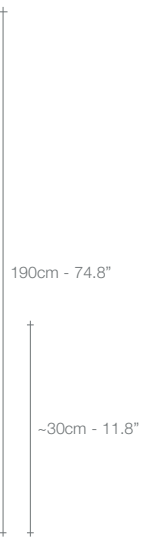
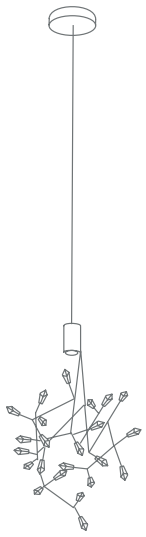

Ø20cm - 7.9"

P22S

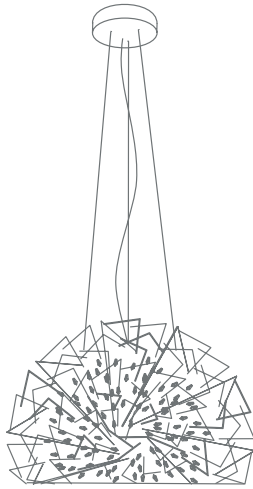

Ø70cm - 27.6"

P21S

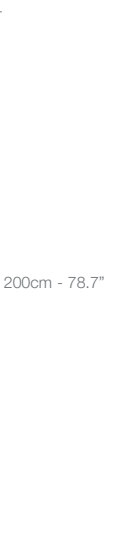
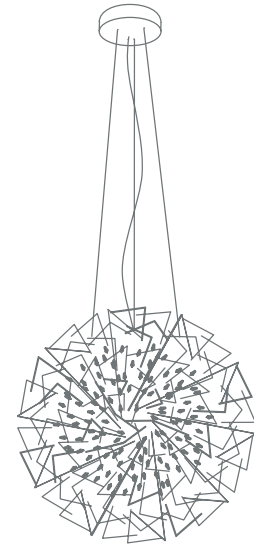

Ø70cm - 27.6"

P20S

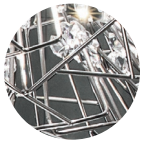





NICKEL CLEAR

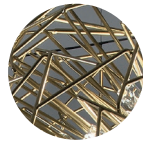

BLACK NICKEL CLEAR



GOLD

	INTEGRATED LED	P20S	P21S	INTEGRATED LED	P22S
230V	 COB LED 3000K-CRI 90	18W 1640lm	18W 1640lm	 LED 3000K	2.1W 240lm
	Dimmer	1-10V PUSH	1-10V PUSH	Dimmer	no
120V	 COB LED 3000K-CRI 90	18W 1640lm	18W 1640lm	 LED 3000K	2.1W 240lm
	Dimmer	TRIAC	TRIAC	Dimmer	no

Different dimming options on request, 2700K LED integrated on request