

ISTRUZIONI INSTALLAZIONE - INSTALLING INSTRUCTIONS - INSTRUCTIONS DE MONTAGE

1 Fix the bracket to the JBOX

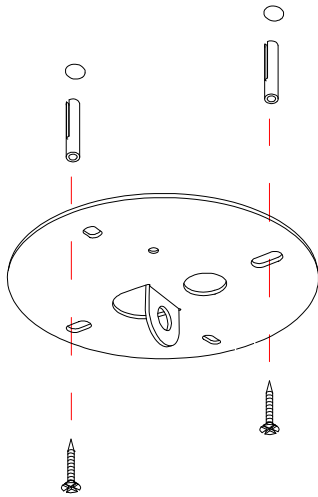

2 Pass the cable through the shade hole

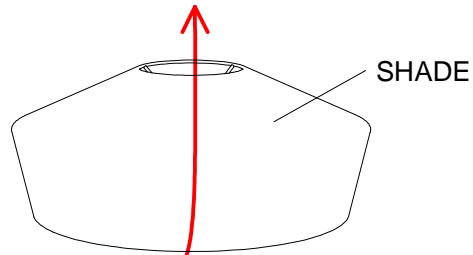

3 Fix the glass with the three screws provided

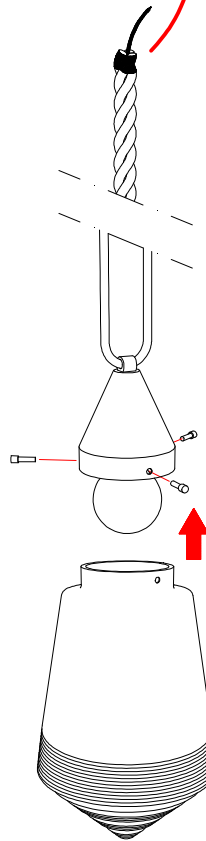

4 Hang up the lamp with the hook

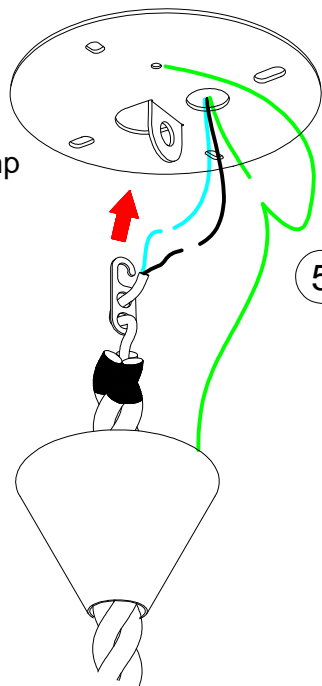

5 Connect the cables following the sketch

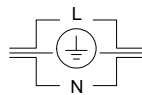

6 Move the collar upwards the canopy and fix it with the screw

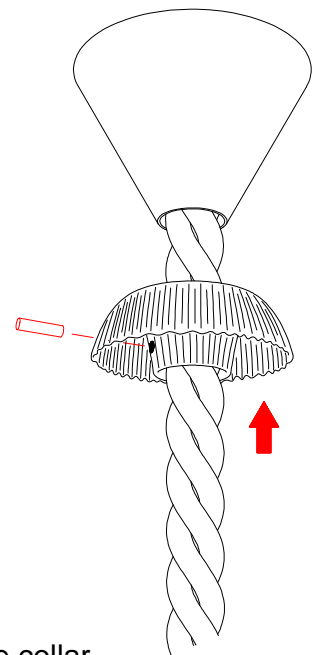

ISTRUZIONI INSTALLAZIONE - INSTALLING INSTRUCTIONS - INSTRUCTIONS DE MONTAGE

CABLE ADJUSTMENT

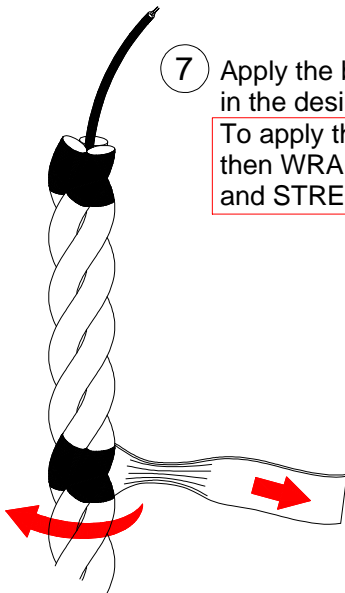

- 7 Apply the black tape provided in the desired position.
To apply the tape remove the white liner then WRAP IT on the cable and STRETCH IT during the application.

- 8 Cut ONLY THE GREEN CORD on the top of the tape

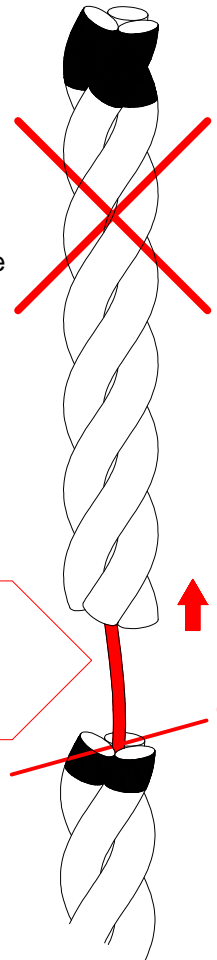

PAY ATTENTION!
DON'T CUT
THE ELECTRICAL
CABLE INSIDE!

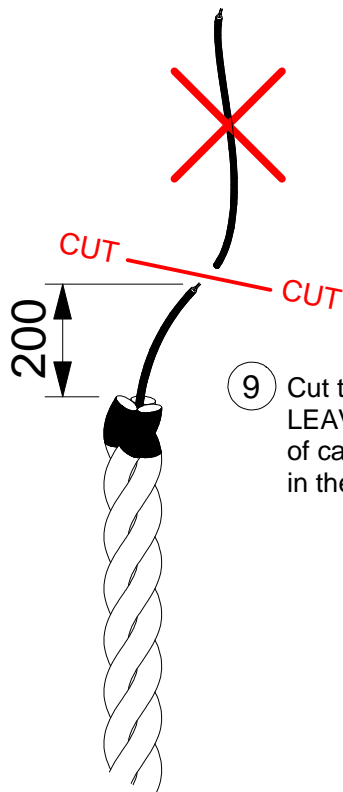

- 9 Cut the electrical cable LEAVE AT LEAST 200 mm of cable for connection in the canopy

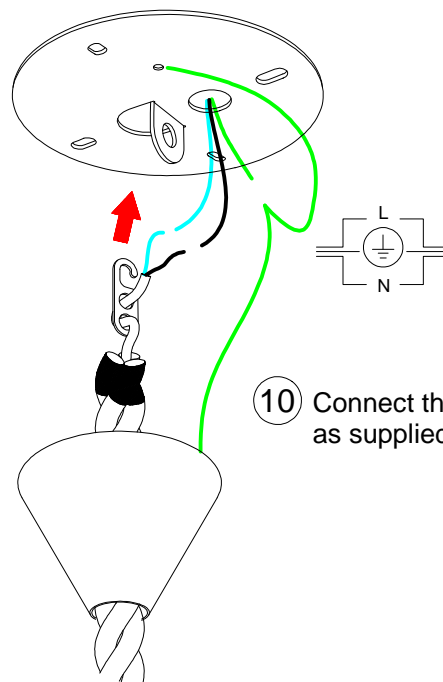

- 10 Connect the cables as supplied at the beginning