

Braided silk cable

Ceramic

SOCKET 1xE26

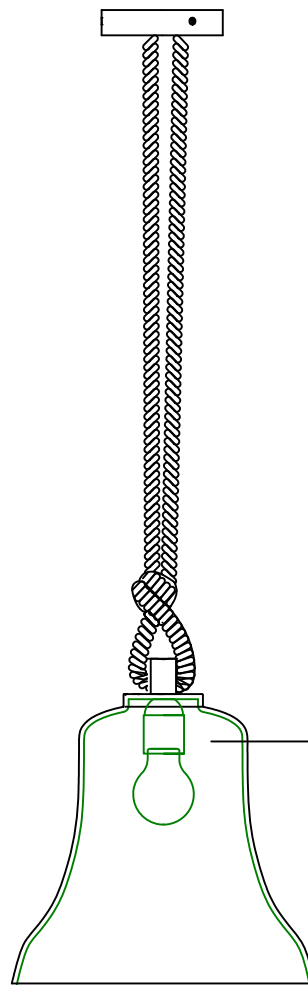
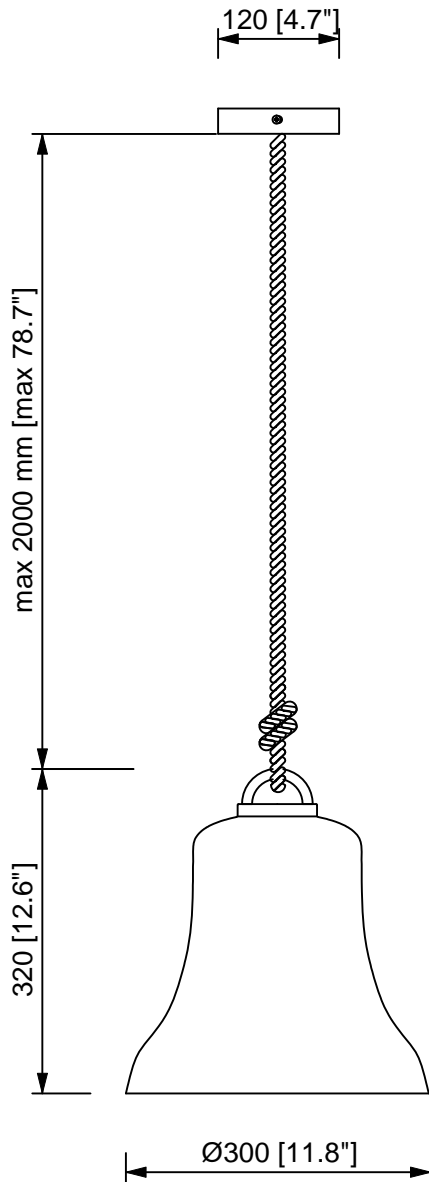

# Belle SO small - USA



LAYOUT

DRAWN BY

UPDATE 07-05-2015 REV. 00

L.U.

"Copyright and/or design rights subsist in this drawing. No part of this drawing may be reproduced in any material form (including photocopying or storing in any medium electronic means, whether or not intentionally and whether or not as part or a larger publication) without the express permission of the copyright owner, Contardi Lighting srl. Further and without prejudice to the above, this drawing and all information relating thereto is confidential, and shall not be communicated to a third party without the consent of Contardi Lighting srl. Contardi Lighting srl asserts all rights to be identified as the author of the work and otherwise.  
 WARNING: the doing of any unauthorised act in relation to a copyright work may result in both a civil claim for damages and criminal prosecution".

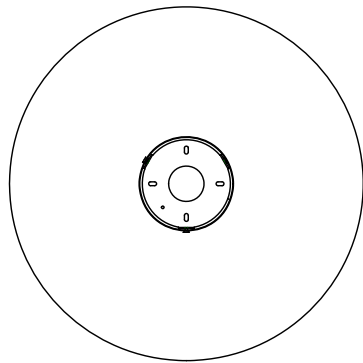

Metal

Braided silk cable

Ceramic

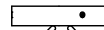
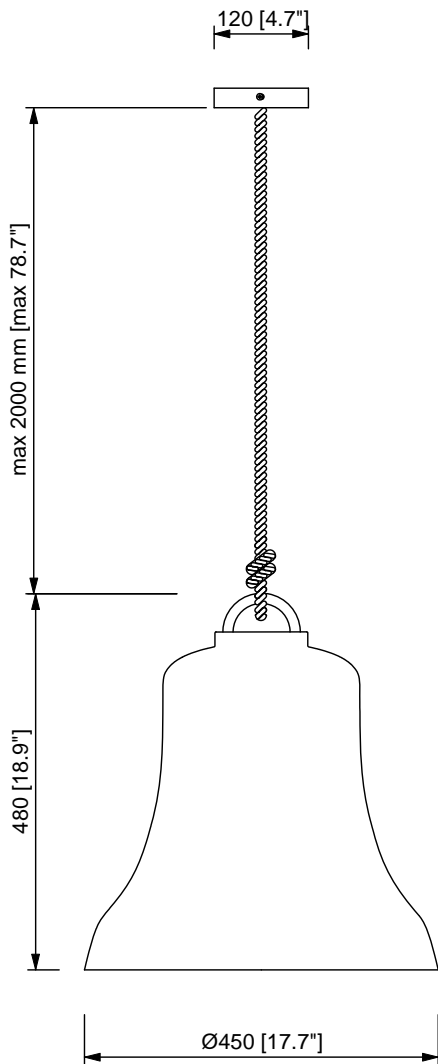
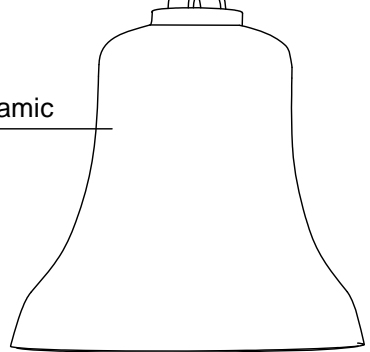

SOCKET 1xE26

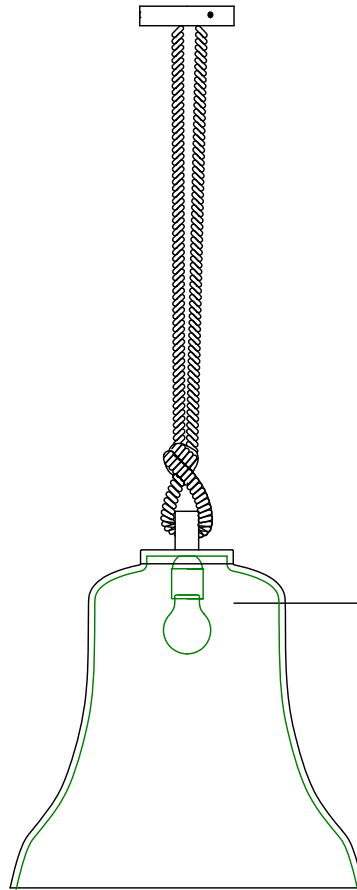

Belle SO - USA



LAYOUT

DRAWN BY

UPDATE 07-05-2015 REV. 00

L.U.

"Copyright and/or design rights subsist in this drawing. No part of this drawing may be reproduced in any material form (including photocopying or storing in any medium electronic means, whether or not intentionally and whether or not as part or a larger publication) without the express permission of the copyright owner, Contardi Lighting srl. Further and without prejudice to the above, this drawing and all information relating thereto is confidential, and shall not be communicated to a third party without the consent of Contardi Lighting srl. Contardi Lighting srl asserts all rights to be identified as the author of the work and otherwise.  
 WARNING: the doing of any unauthorised act in relation to a copyright work may result in both a civil claim for damages and criminal prosecution".