

artek
www.artek.fi

LIGHT A330S

GOLDEN BELL / CHROME BELL

DESIGN ALVAR AALTO 1939

artek

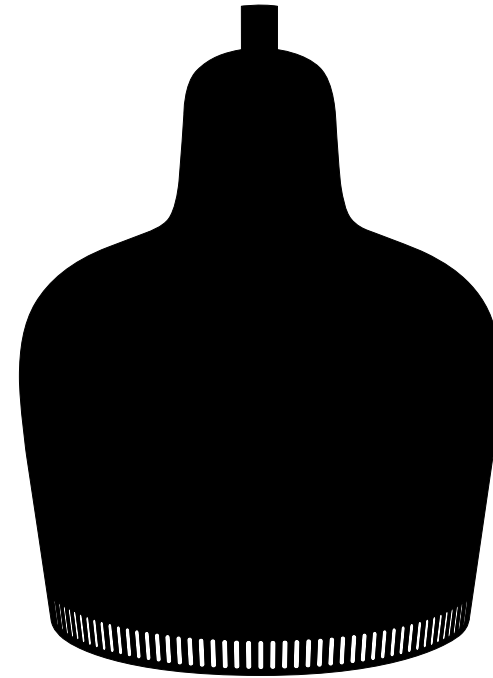

BEFORE YOU START

Read these instructions carefully before commencing installation. Do not attempt to fit installation unless you are competent. If in any doubt consult a qualified electrician. Before commencing installation ensure that the power supply is disconnected at the fuse box. The lighting is intended for use in a normal dry indoor environment. Avoid mounting the fitting on a damp surface as this may cause discoloration of the finish.

CONTENTS

Tools needed: Screwdriver.

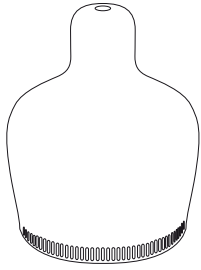

1 x shade

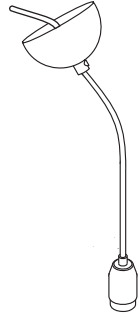

1 x light fitting

CLEANING INSTRUCTIONS AND CARE

Take care when handling and installing to avoid damage to the product. Do not use any chemical or abrasive agents or water to clean the shade. A non-static duster can be used to clean the shade.

WIRING

Before commencing installation ensure that the power supply is disconnected at the fuse box. Adjust the lengths of the cable using the cable grip and grub screw. Make sure that the cable grips are tight.

Check that:

- There is an earth conductor connected to the incoming earth at the fuse box
- You have identified the mains cable correctly
- The connections are tight
- No loose strands have been left out from the connector blocks

1

Screw fix the metal bracket onto the ceiling making sure that the power source is still accessible.

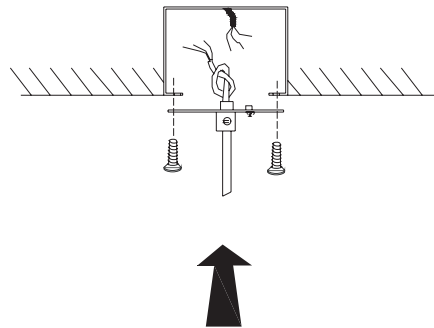

2

Connect the fitting and the individual earth to the mains cable. Twist loose strands at the end of lighting and ceiling cables. Feed them through the orange cones provided to secure the connection. Make sure you are matching the corresponding cables of ceiling and lighting as per diagram.

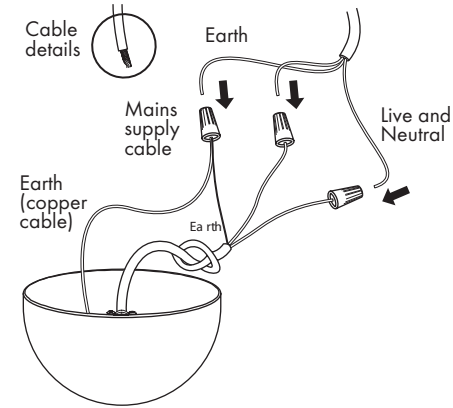

3

Assemble the pendant cup components onto the ceiling as shown below. Assemble the pendant cup onto the ceiling bracket. Ensure that the cable is not stressed/pressed against anything.

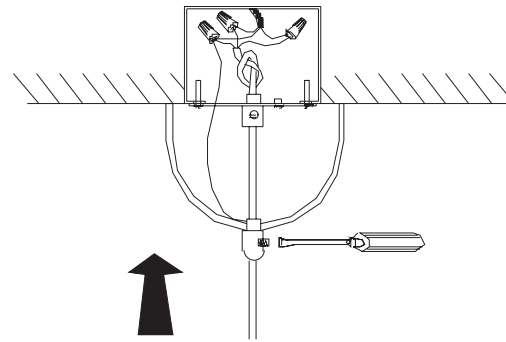

4

Control cable's length by unscrewing the cable grip screw and sliding the cable through. Restore power at the fuse box. Your product is now ready to use.

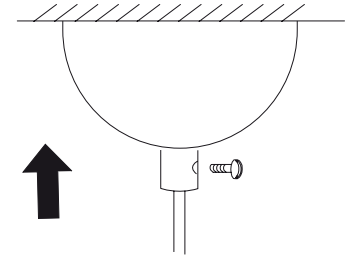

BULB REPLACEMENT

E26, 11W compact fluorescent light bulb or 40W incandescent light bulb. Dispose of old bulbs with care. Fit bulb onto the light fitting as per the diagram below.

