

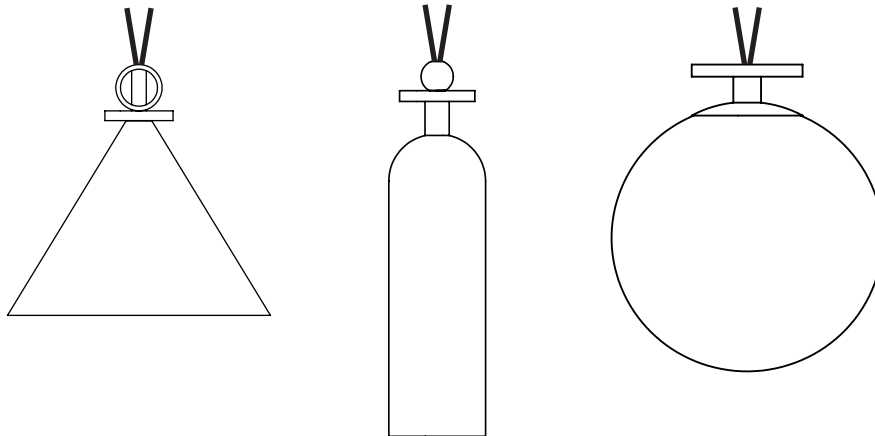

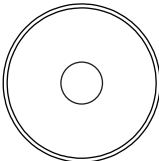





CONTENTS

Shape Up 3-Piece Chandelier
 Cone + Cylinder + Globe



<p>Canopy with Hub</p> 	<p>Ceiling Hubs (2)</p> 	<p>8-32 Crossbar Screws (2)</p> 	<p>Strain Relief (6)</p> 
<p>1/4-20 Anchor Screw (2)</p> 	<p>1/4-20 Ceiling Anchor (2)</p> 	<p>Crossbar 1/8 IPS</p> 	<p>Wago Connector (3)</p> 

SAFETY INFORMATION

Only one light bulb per socket.
 Only suitable for direct mounting on non-combustible surfaces.
 Under no circumstances can Shape Up fixtures be mounted on normally flammable surfaces.
 Suitable for dry, indoor use only.
 Maximum ambient temperatures: 25° C

CEILING INSTALLATION | SHAPE UP 3-PIECE CHANDELIER

Note: Please contact a licensed electrician.

1. Prepare junction box for installation. Secure crossbar (A) to junction box (B) using provided 8-32 screws (C). Screw provided 1/4 IPS nipple (D) into center of crossbar.

2. Connect wires from the provided voltage transformer (E) to the lead wires in the ceiling. Store in junction box until step 6.

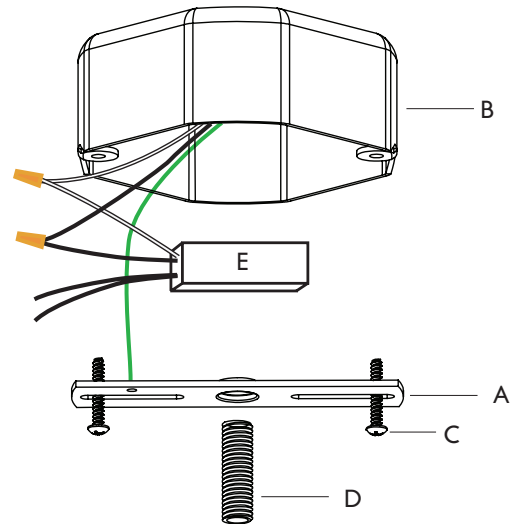

3. Mark two points on ceiling where two connection hubs (F) will be placed. The two hubs and junction box should form an equilateral triangle, each hub approximately 35 inches apart.

4. Mount hubs (F) to ceiling using provided anchors.

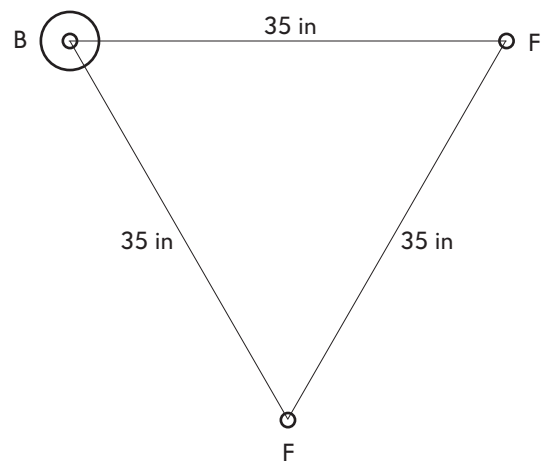

CEILING INSTALLATION | SHAPE UP 3-PIECE CHANDELIER

5. Measure the desired drop length of your fixture from the ceiling. Then use the chart below to determine the length of fabric cord necessary for each piece. Add approximately 3-4 inches of extra cord for wiring.

OVERALL DROP LENGTH	CORD LENGTH:		
	CONE	GLOBE	CYLINDER
8'	5'6"	7'3"	6'3"
7'	4'6"	6'3"	5'3"
6'	3'6"	5'3"	4'3"
5'	2'6"	4'3"	3'3"
4'	1'6"	3'3"	2'3"

EXAMPLE | OVERALL DROP LENGTH OF 6'

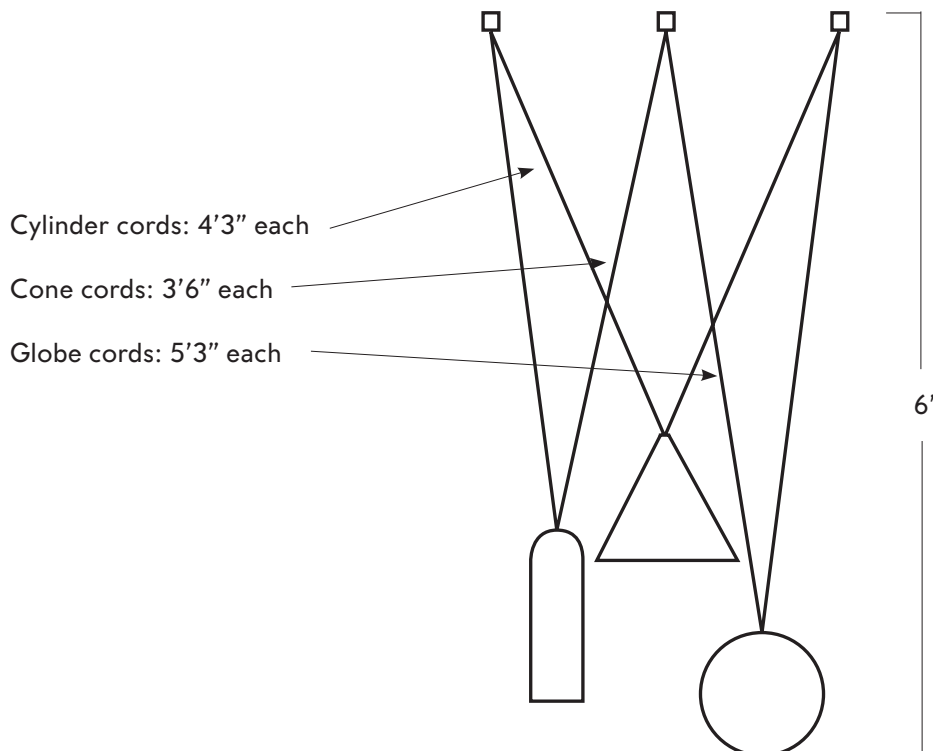

CEILING INSTALLATION | SHAPE UP 3-PIECE CHANDELIER

6. Hang each fixture one at a time. Unscrew caps from ceiling hubs and feed cords into appropriate side holes. Once cord is through hole, secure strain relief tightly around cord, leaving an extra 2-3 inches to make wire connections. This will secure the weight of each fixture before making wire connections.

7. Strip ends of wires and make connections in each hub. For the main electrical connection to the junction box, first pull lead wires through hole in canopy and then tighten flush to ceiling. Tighten hub onto canopy and connect the three lead wires together using a Wago connector.

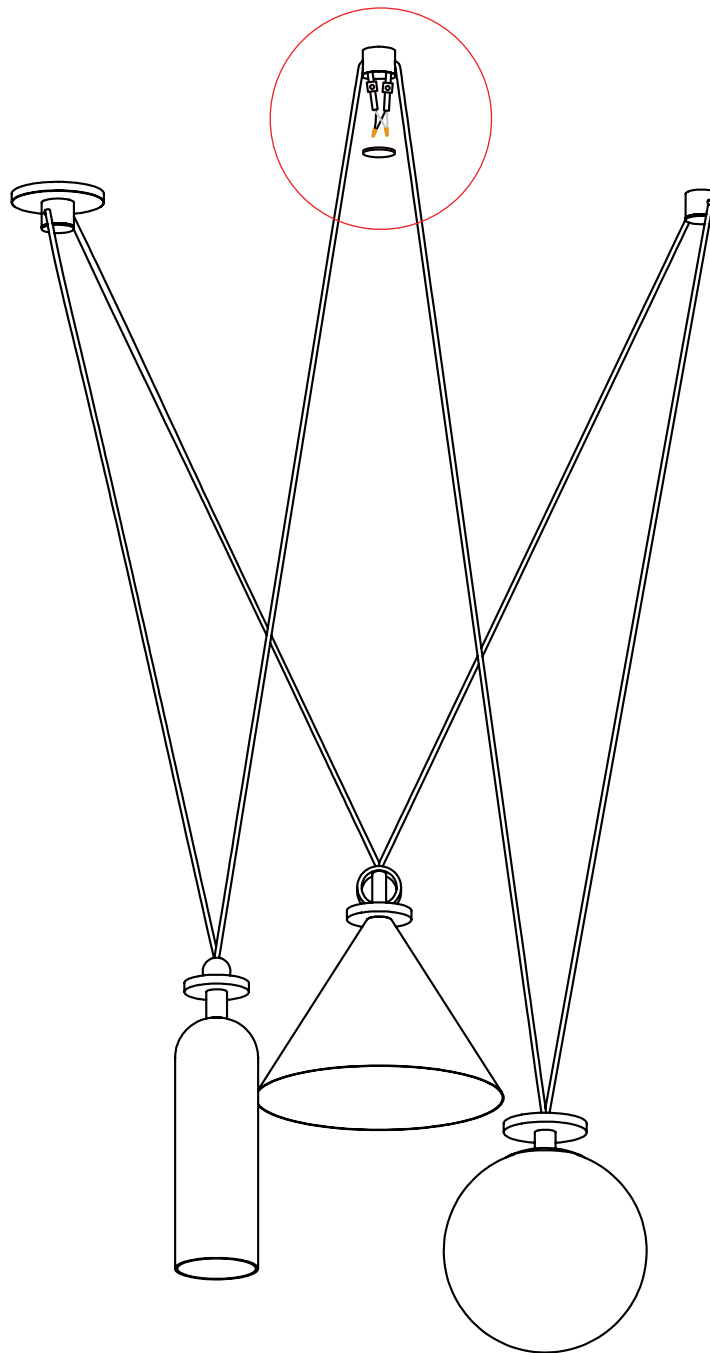

CHANGING THE BULBS

Note: Make sure to power off fixture and allow bulbs and lamp to cool.

CONE AND HEMISPHERE:

Carefully unscrew white bulb in counterclockwise direction and remove from fixture. Pull out existing LED and replace with a new one by pushing two pins into socket. Screw white bulb back onto socket.

CYLINDER:

While holding the glass cylinder shade, carefully unscrew white bulb in counterclockwise direction. This will remove both shade and white bulb. Pull out existing LED and replace with a new one by pushing two pins into socket. Hold shade in position and screw white bulb back onto socket.

ARC:

Support weight of glass arc shade and unscrew the small black cap from each end in counterclockwise direction. This will remove the glass shade from the assembly. Pull out existing LED and replace with a new one by pushing two pins into socket. Put glass arc shade back into place by screwing caps back onto end caps.

GLOBE:

Support weight of glass globe while unscrewing black cap from top of assembly. Slide black cap and brass tube up the cord and loosen the nut holding the globe cap to globe. Once loose, slide globe off of internal fitter and cap and set aside. unscrew white bulb in counterclockwise direction and remove from fixture. Pull out existing LED and replace with a new one by pushing two pins into socket. Screw white bulb back onto socket and re-fit the assembly.