

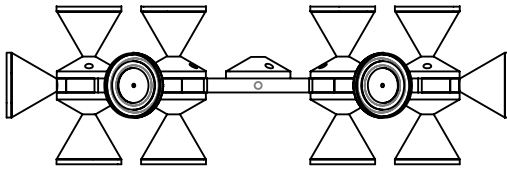







CONTENTS

<p>Castle 18</p> 	<p>Glass Diffuser X 6</p> 	<p>Stem and 1/8 IPS Threaded Rod</p> 	
<p>Glass Diffuser x 12</p> 	<p>Crossbar</p> 	<p>Canopy</p> 	<p>Driver</p> 
<p>8/32 J-Box Screws</p> 	<p>LED Bulb x 9</p> 	<p>Hangstraight</p> 	

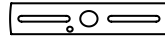
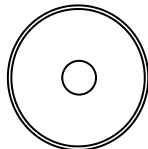
SAFETY INFORMATION

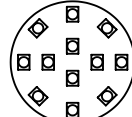
Only suitable for direct mounting on non-combustible surfaces.
 Under no circumstances can Halo Chandeliers be mounted on normally flammable surfaces.
 Suitable for dry, indoor use only.
 Maximum ambient temperatures: 25° C

CASTLE CHANDELIER | CEILING INSTALLATION

Note: Please contact a licensed electrician.

1. To customize the length of the provided 36-inch stem, you may cut to desired length. Then cut the inner all-thread tube to the same length plus 1/2 inch to allow room for threading.

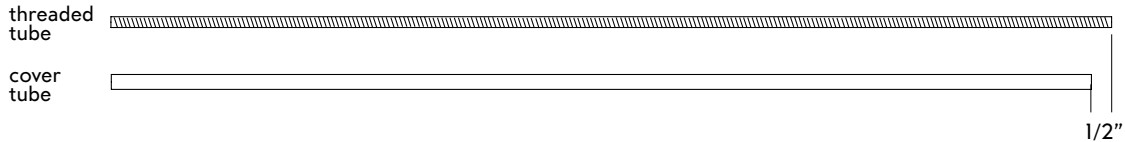

2. Feed wire from the fixture through the threaded rod. Thread the rod a quarter inch into the top hub of the fixture (A).

3. Slide the cover tube (B) over the threaded tube.

4. Slide the collar (C) of the hangstraight down the cover tube, followed by the canopy (D).

5. Screw the hangstraight (E) onto the remaining quarter inch at the top of the threaded tube.

6. Screw the 1/8 IPS nipple (F) onto the top of the hangstraight, and then the crossbar (H).

7. Connect Driver (J) to fixture wires (K) and the ceiling power (I) using wire nuts, then tuck driver into junction box

8. Secure crossbar to junction box (G) in ceiling using provided 8-32 crossbar screws. Connect lead wires. Raise canopy to junction box and thread collar onto hangstraight until canopy is flush with ceiling.

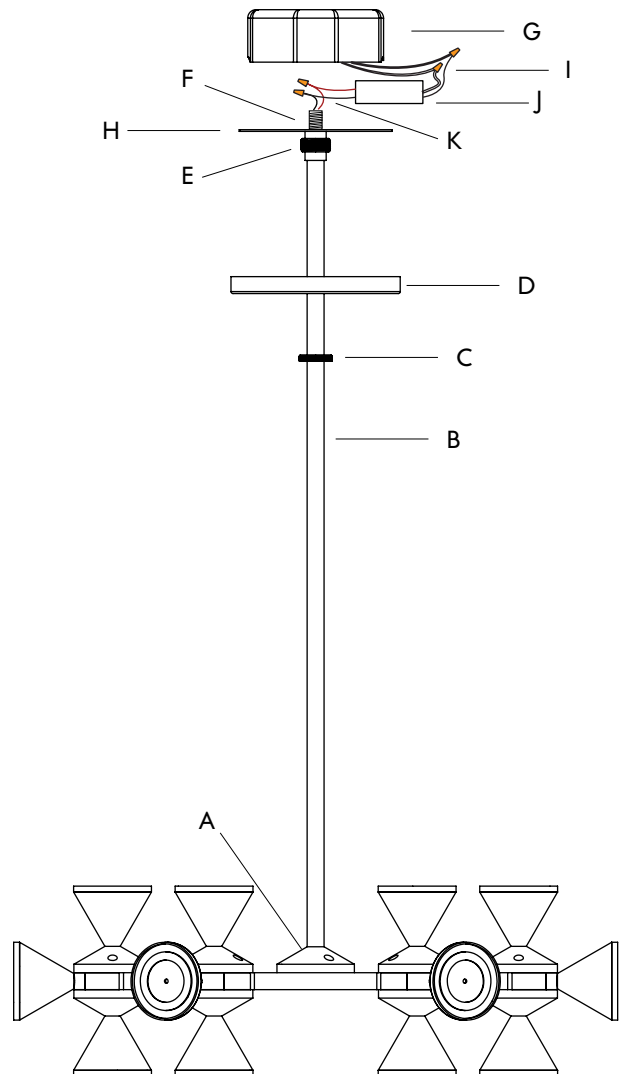

CASTLE CHANDELIER | BULB AND DIFFUSER INSTALLATION

1. Install supplied LED bulb (A) by sliding pins into socket (D)
2. Screw the glass diffusers (C) clockwise into threaded hub (B)

