

# BuzziPleat LED

INSTALLATION MANUAL

110V - 120V

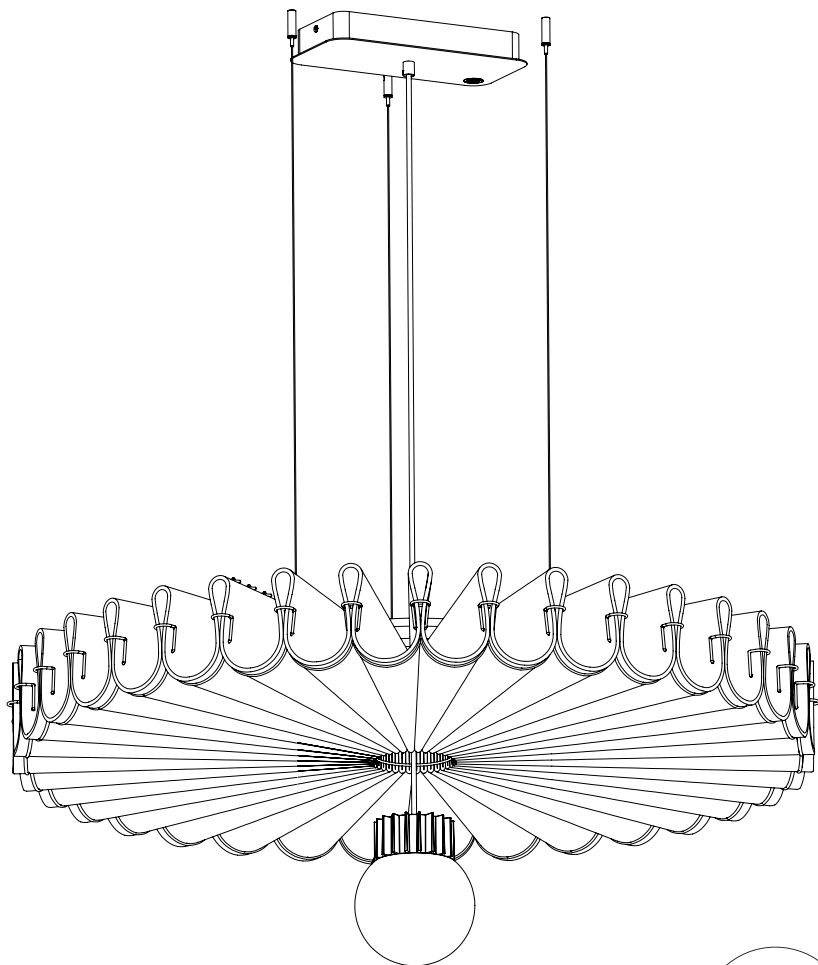

## Technical info

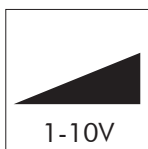
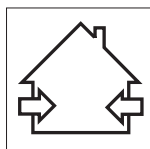
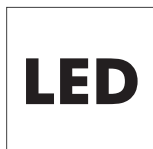

**▲** The light source of this luminaire is not replaceable; when the light source reaches its end of life the whole luminaire shall be replaced.

## Excl.



3x



2x

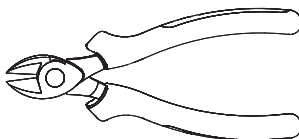
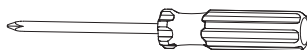
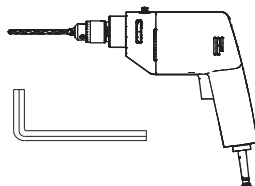
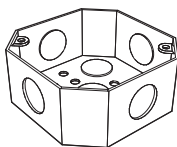
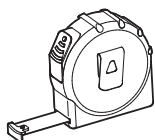

## Incl.

**BuzziPleat Ripple**

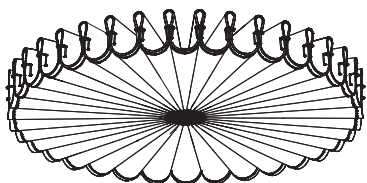

**BuzziPleat Edel**

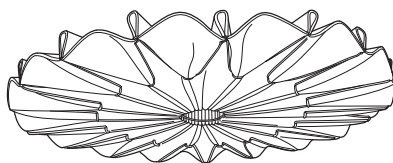

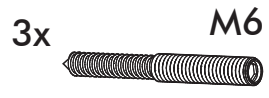
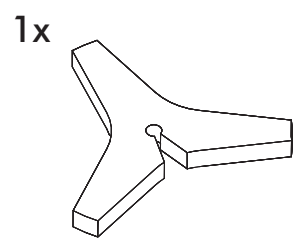
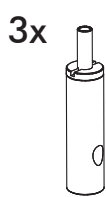
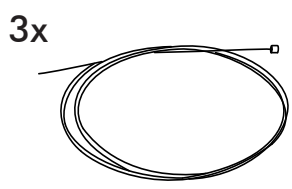
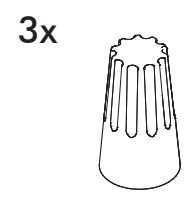
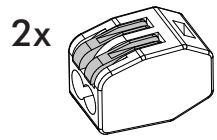
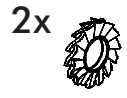
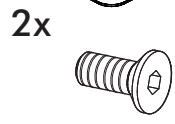
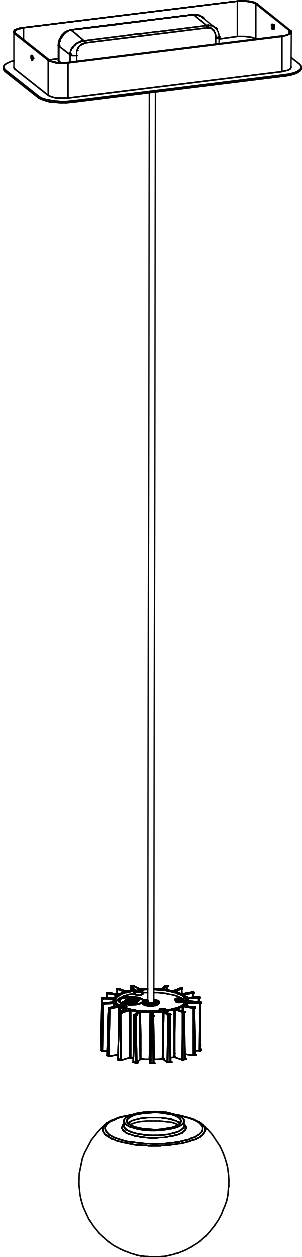

# BuzziPleat LED

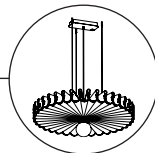

2 PERS. 

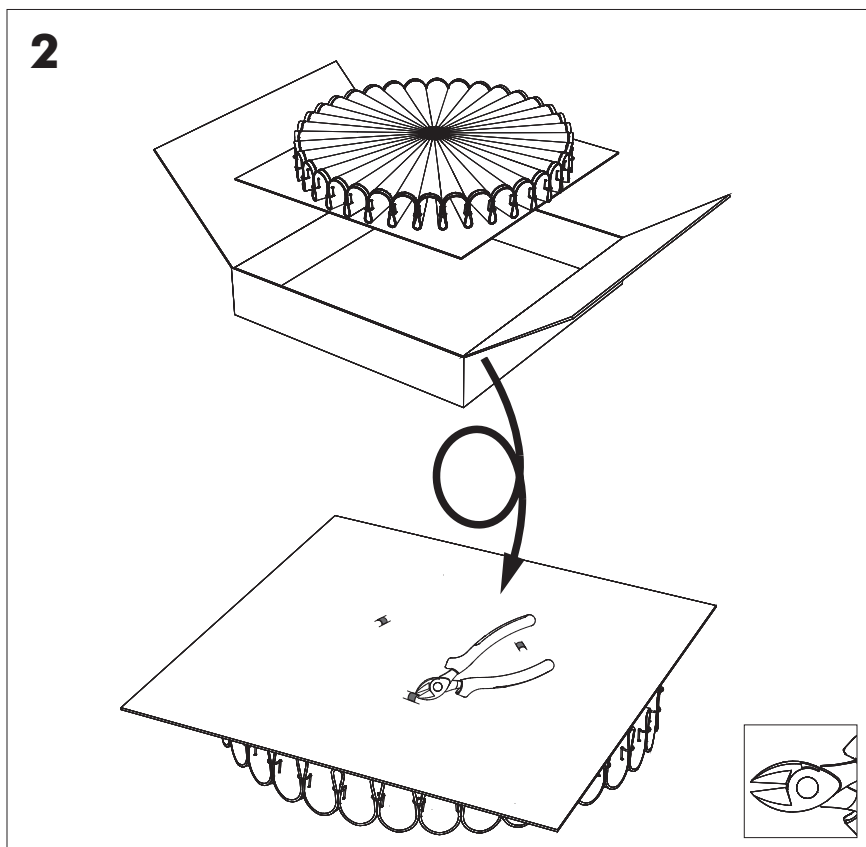
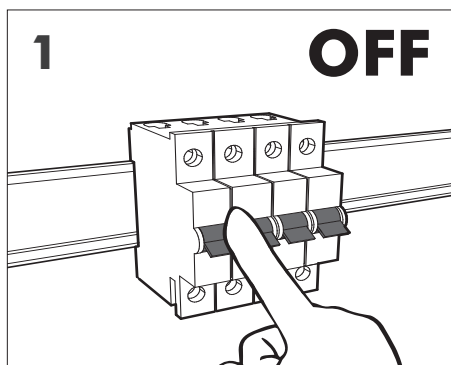

3

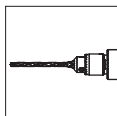
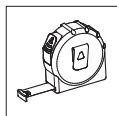
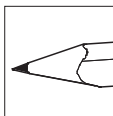
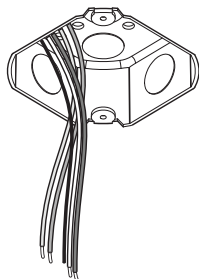
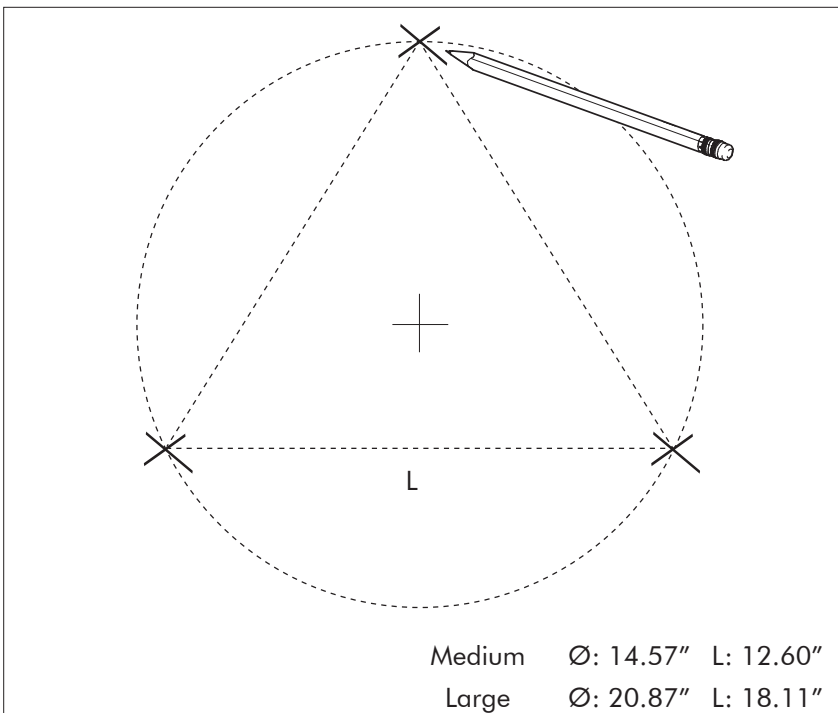

4

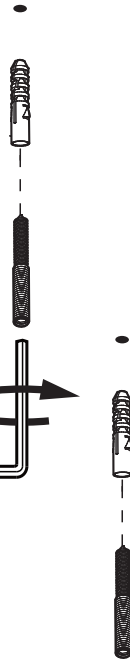
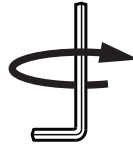
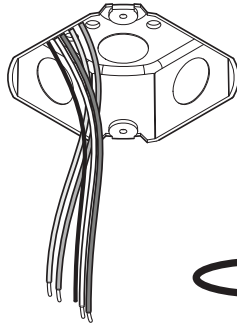
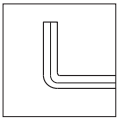

5

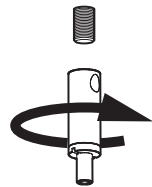
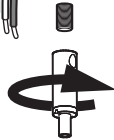
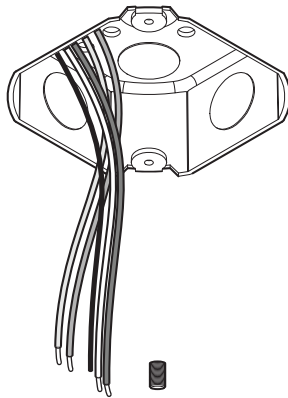
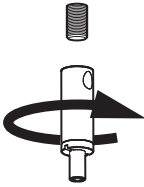

6

6

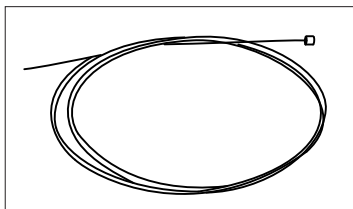
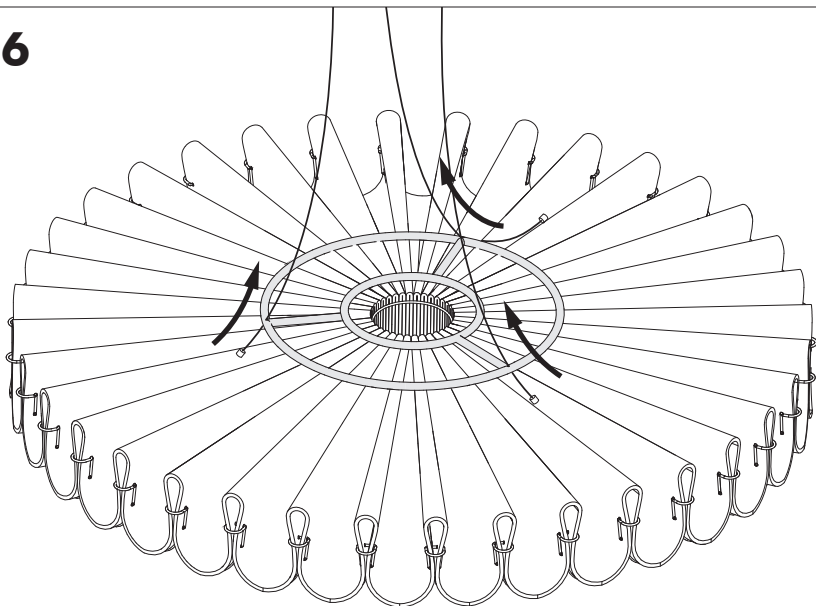

7

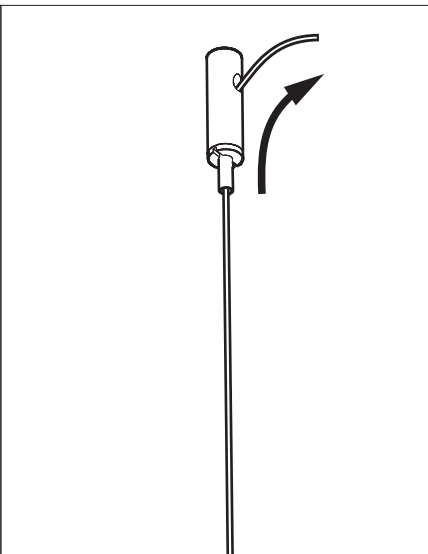
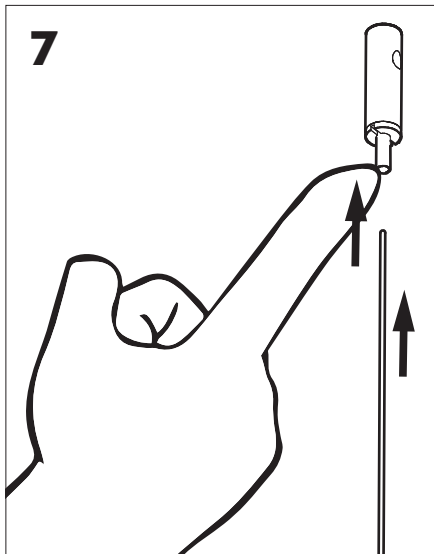

# 8a

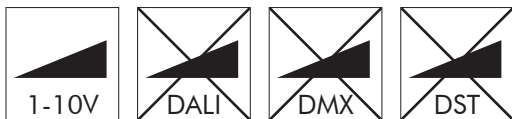

Connection including dimmable function

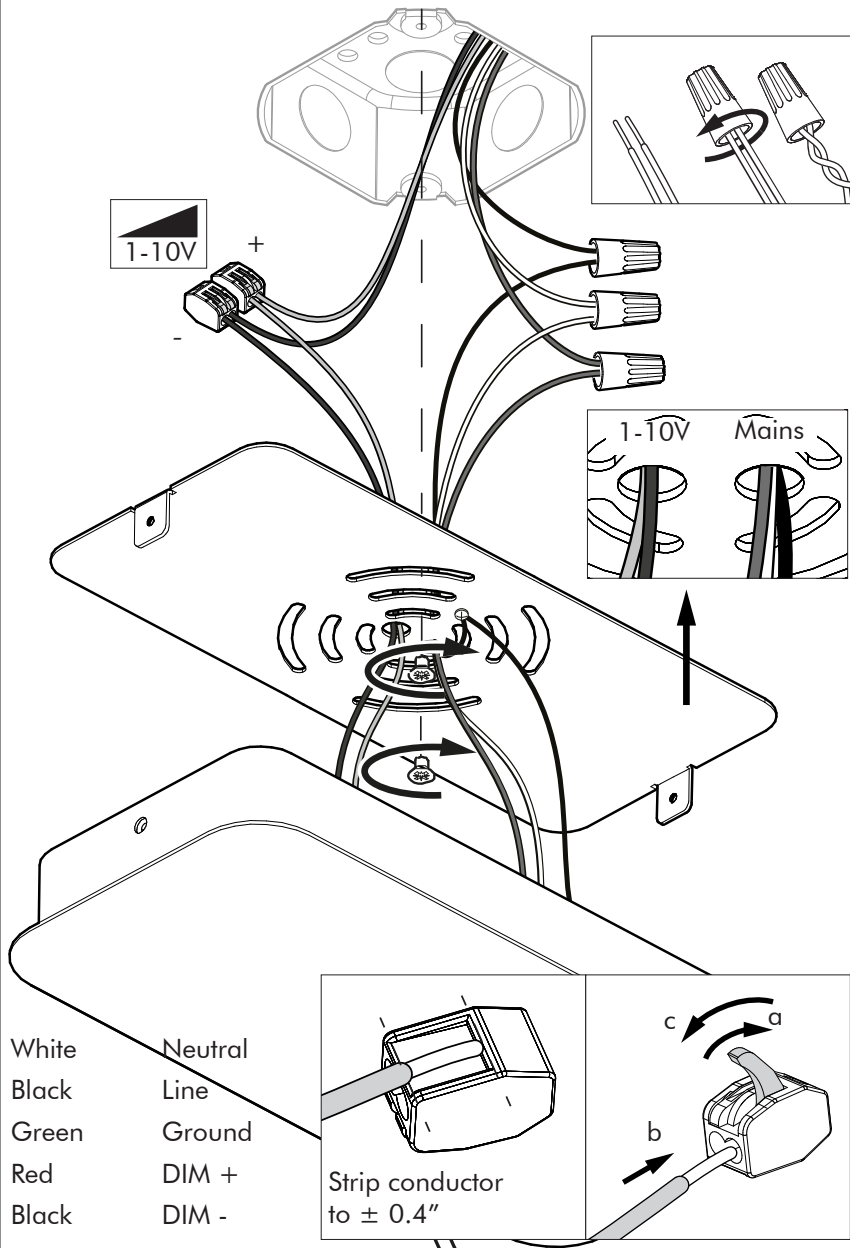



# 8b

## Connection excluding dimmable function

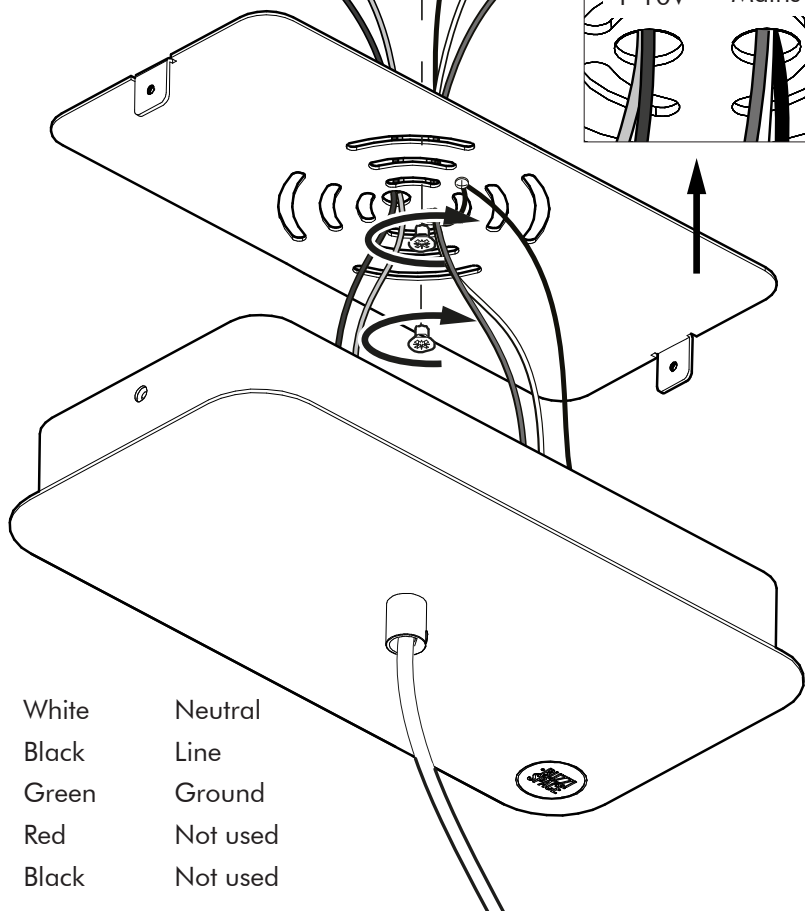
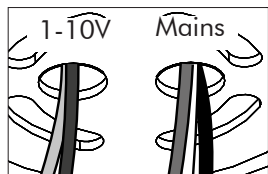
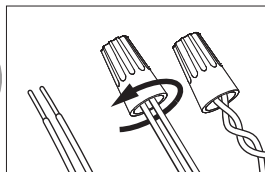
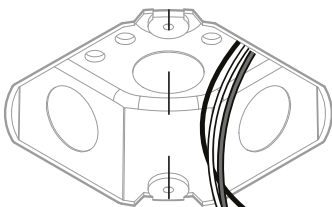
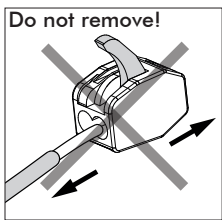

9

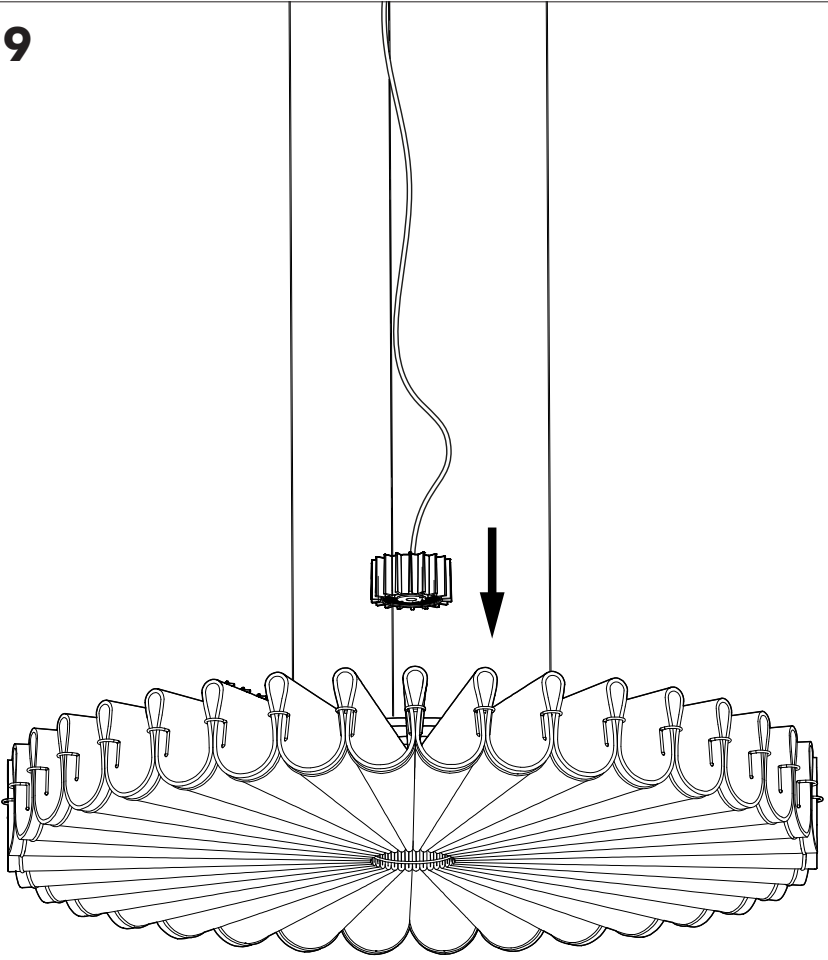

10

10

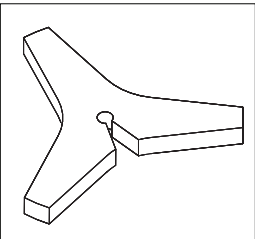
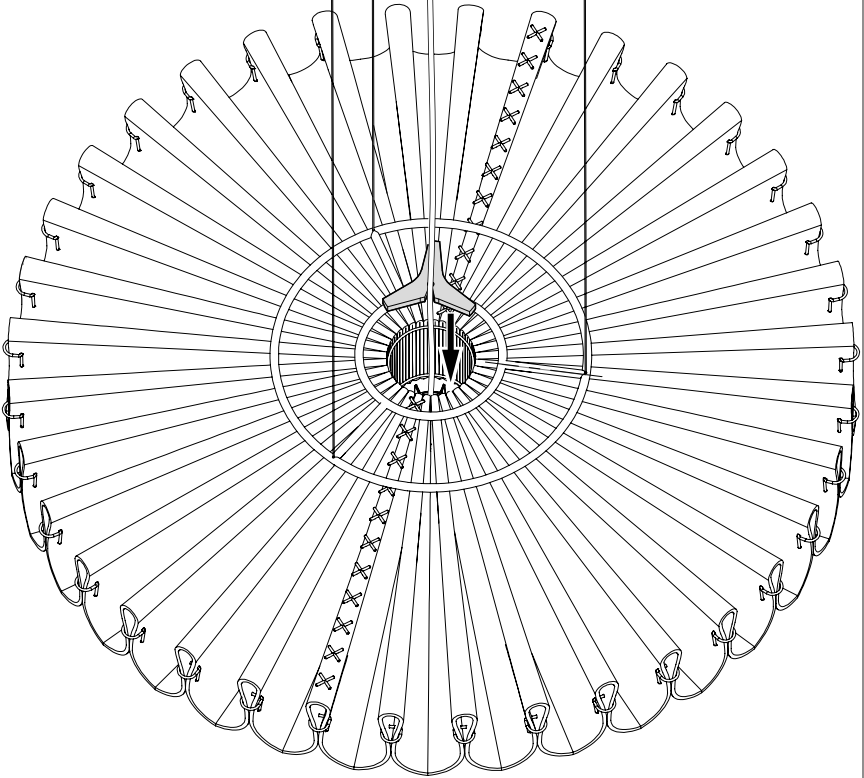
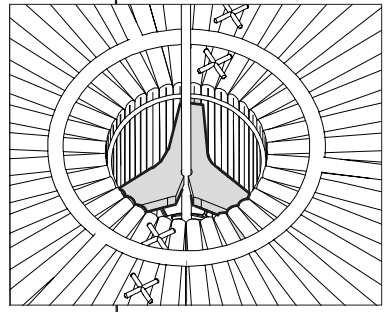

11

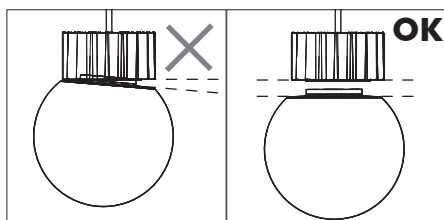
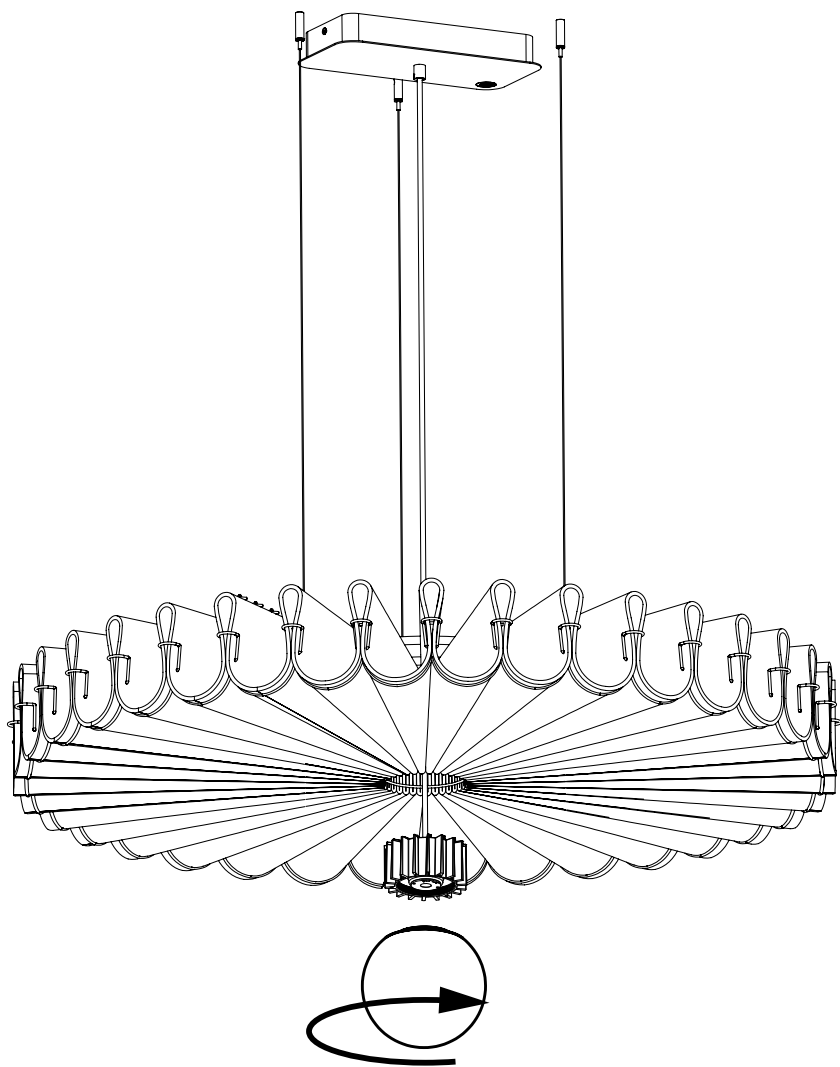

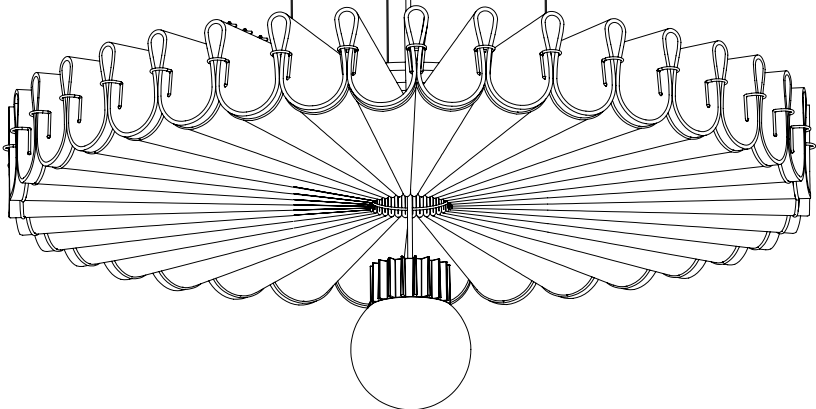
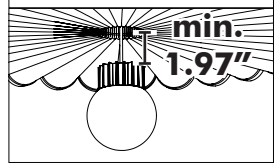
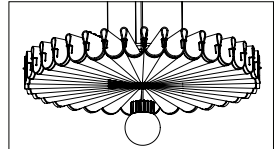
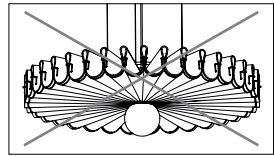
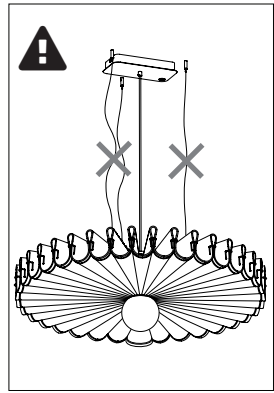
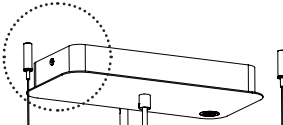
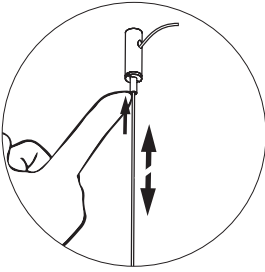





BuzziSpace  
Groeningenlei 141  
2550 Antwerp, Kontich  
Belgium  
☎ +32 (0)3 846 10 00  
✉ info@buzzi.space  
🌐 www.buzzi.space



Doc nr.: A-0000003382/02  
Last update: 18/07/2019