



---

## **BuzziMoon 100 - 120V Product Specification Sheet**

---

This document contains technical information  
about the BuzziMoon



[www.buzzi.space](http://www.buzzi.space)





## Embedded light

BuzziMoon offers the best of both worlds; highly functional general lighting embedded in a proven acoustic ceiling solution. One of the first acoustical lighting solutions that is equally performant on lighting as on acoustic level. The LED light module is designed specifically to answer the request of general lighting in office space. The Moon can be finished off in different fabrics and various 3D patterns. The LED module has an output of 2500 lumen at a colour temperature of 3000K. The diffuser gives it a “full moon” lighting experience. BuzziMoon is equally available in EU and US.

Design by BuzziSpace Studio

---

## General

-  Round, Oval
  - LED disk: Powder coated metal body
  - Opaque diffuser
-  Acoustic Panel: Honeycomb cardboard
  - Acoustic foam filling
  - Upholstered acoustic panel
- Wattage: 29,4W  
Input Voltage: 100 - 120V  
Input Frequency: 50/60Hz  
Lumen output: 2545 lumen
-  Color Temperature: 3000K  
Color Rendering Index: 90  
Unified glare rating: 22 (version with prismatic diffuser UGR 19 on request)  
Efficacy: 87 Lm/W  
Dimmable 1-10V Protocol
-  IP20 Dry usage
- ...  
Round: Flat, 3D Drop, 3D leaf, 3D Rib  
Oval: Flat, 3D leaf, 3D Rib
-  Assembled

---

## Certifications

cULus Listed

---

## Acoustics



Absorption



Diffusion



Mid tone



High tone

---

## Content

Configurations	3	Fabrics	8
Composition	4	Dimensions	11
Patterns	5	Acoustics	14

# Configurations

---

## BuzziMoon Round

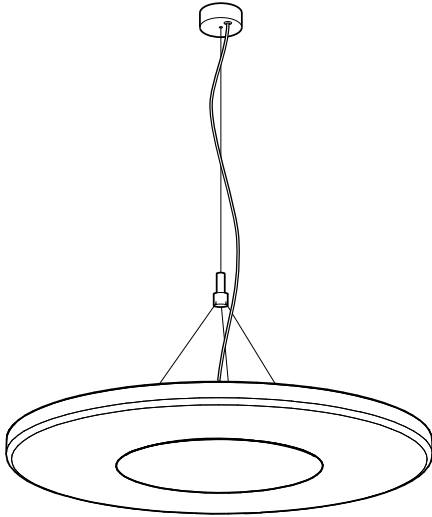

Acoustic panel upholstered in CAT A, B, C, D, E  
LED disk integrated in an upholstered acoustic panel  
3 silver metal suspension cables  
White powder coated metal ceiling canopy  
Transparent power cable



R-S Ø 31.50"  
R-M Ø 39.37"  
R-L Ø 47.24"



R-S: 20.94 lbs  
R-M: 25.35 lbs  
R-L: 29.76 lbs



... Flat, 3D Drop, 3D leaf, 3D Rib



If installing on suspended ceiling, verify load capacity prior to installation.

---

## BuzziMoon Oval

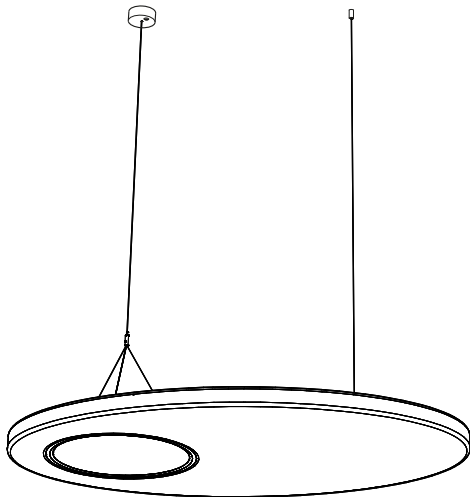

Acoustic panel upholstered in CAT A, B, C, D, E  
LED disk integrated in an upholstered acoustic panel  
4 silver metal suspension cables  
White powder coated metal ceiling canopy  
Transparent power cable



O-S W 31.50" L 47.24"  
O-M W 37.50" L 56.69"



O-S: 22.05 lbs  
O-M: 26.46 lbs

... Flat, 3D Leaf, 3D Rib



If installing on suspended ceiling, verify load capacity prior to installation.

# Composition

---

## LED Disk



The LED disk has an aluminium frame which is finished in fine textured white powder coating. The PMMA diffuser ensures an optimal light spread and efficiency. It creates a very diffuse light surface without any dottiness. The light source of the Buzzimoon is a LED PCB, containing 36 low power LED's.

To enlight your workplace or room with optimal lux levels take following measures into account.

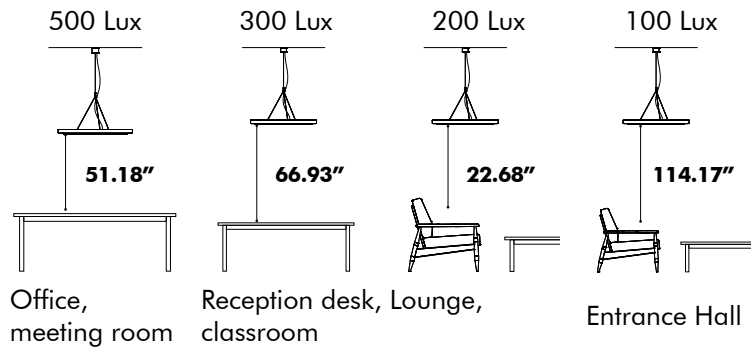

\* According to EN12464

## Suspension Set



Suspension set consists of a:

- metal ceiling canopy powder coated in white
- transparent power cable (length 157.48")
- silver metal cables to suspend the BuzziMoon (length 157.48")
- single silver metal cable exits the ceiling canopy and splits up into 3 metal cables to connect to the BuzziMoon
- BuzziMoon Oval has 1 additional metal cable

## Acoustic Panel



The acoustic panel is upholstered front to back in a chosen fabric. The panel consists of honeycomb cardboard, MDF and acoustic foam filling.

# Patterns Round

---

## Flat

**L**

**M**

**S**

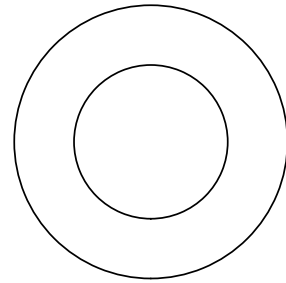
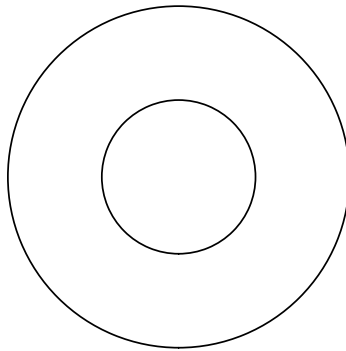
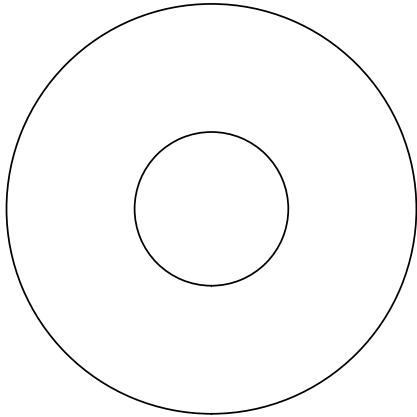

---

## 3D Rib

**L**

**M**

**S**

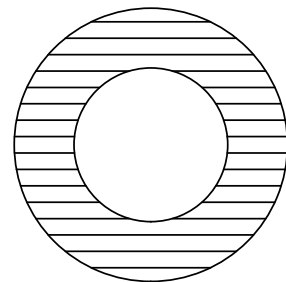
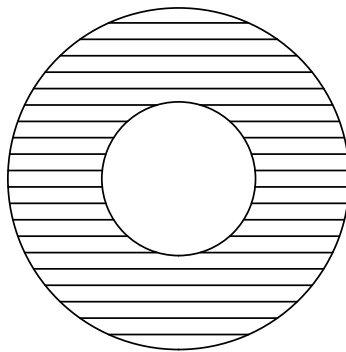
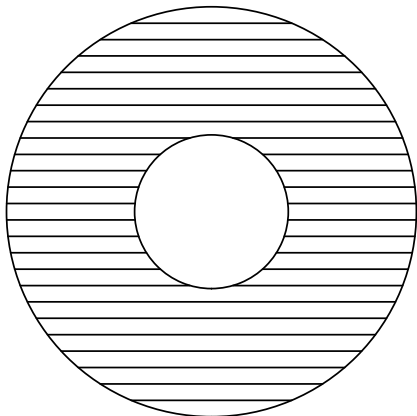

---

### 3D Leaf

L

M

S

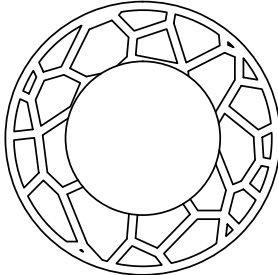
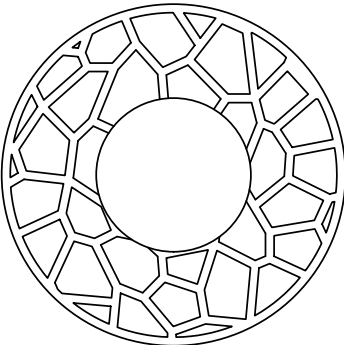
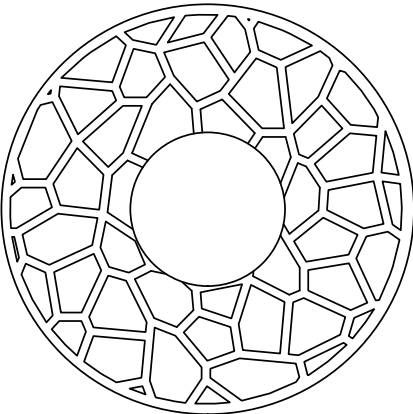

---

### 3D Drop

L

M

S

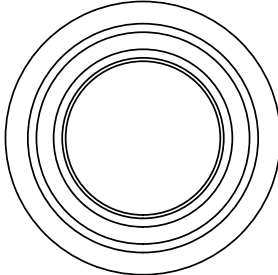
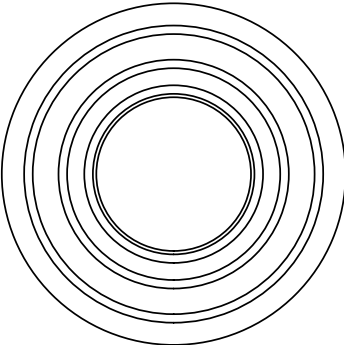
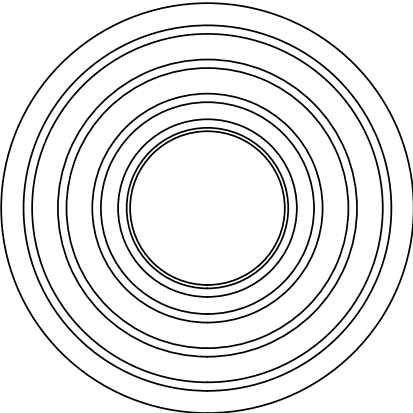

# Patterns Oval

---

## Flat

M

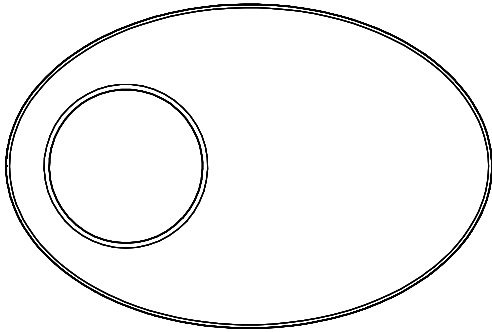

S

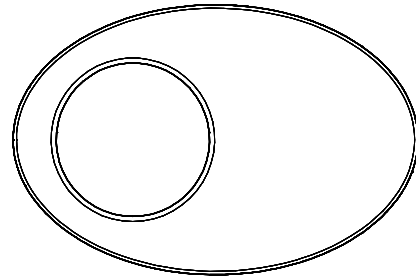

## 3D Leaf

M

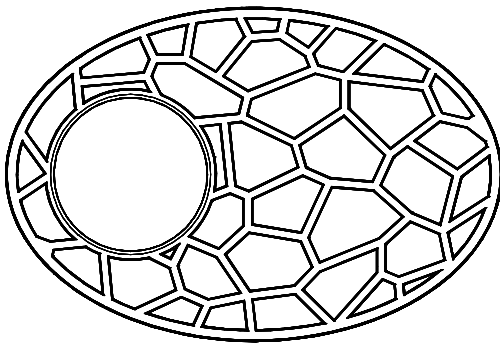

S

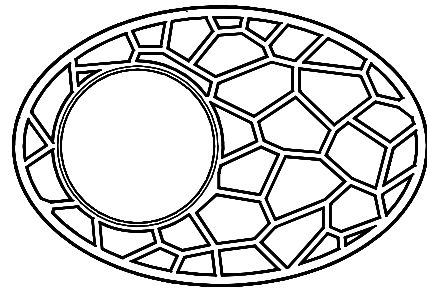

## 3D Rib

M

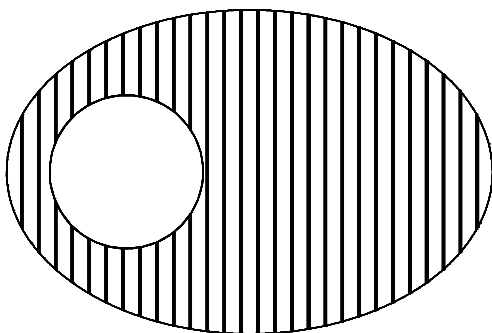

S

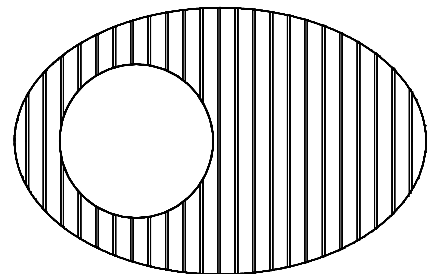

# Fabrics

## Fabric

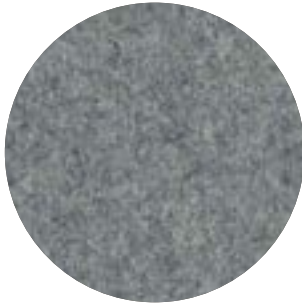

**Category A**

**Composition** 70% Recycled Wool, 25% Recycled Polyacryl,  
5% Recycled Other Fabrics

**Weight** 405 g/m<sup>2</sup> | 11.94 oz/yd<sup>2</sup>

**Abrasion resistance** 40.000 Martindale, 50,000 Wyzenbeek

**Flammability** EU: EN 1021.1/2006 | BS EN 1021.1/2006 (cigarette).  
EN 1021.2/2006 | BS EN 1021.2/2006 (match)  
USA: CAL TB 117 | ASTM E84 CLASS A

**Fastness to light** EU: 4 | USA 4

**Fastness to rubbing** EU: Wet 3-4 | Dry 4-5

**Fastness to crocking** USA: Wet 5 | Dry 5



## Rough

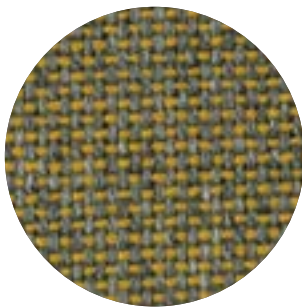

**Category A**

**Composition** 100% Polyacryl

**Weight** 456 g/m<sup>2</sup> | 13.45 oz/yd<sup>2</sup>

**Abrasion resistance** 40.000 Martindale

**Flammability** EU: EN 1021.1/2006 | BS EN 1021.1/2006 (cigarette)  
USA: CAL TB TB 117

**Fastness to light** EU: 5

**Fastness to rubbing** EU: Wet: 3 | Dry: 3



## Trevira CS+ | CS

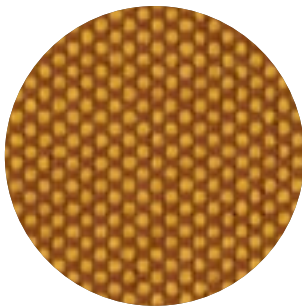

**Category A**

**Weight** 420 g/m<sup>2</sup> | 12.39 oz/yd<sup>2</sup>

**Composition** 100% Polyester, Trevira CS

**Abrasion resistance** 100.000 Martindale, 90,000 Wyzenbeek

**Flammability** BS 5852 part II: CRIB 5 | BS 7176 Medium Hazard  
USA: CAL TB 117 | M1 | B1 | EN 1021/1-2 | C1 |  
IMO Res. A652 (16)

**Fastness to light** EU: 6 | USA 5

**Fastness to rubbing** EU: Wet 4-5 | Dry 4-5

**Fastness to crocking** USA: Wet 5 | Dry 5



## Revive 1



**Category A**

**Composition** 100% recycled polyester FR

**Weight** 430 g/lin.m

**Abrasion resistance** 60.000 Martindale rubs, EN ISO 12947

**Flammability** EN 1021-1/2 | DIN 4102 B1 | Önorm B1/Q1  
UNI 9175 1IM | US Cal. Tech. Bull. 117  
IMO A.652 (16)

**Fastness to light** Note 5-7, ISO 105-B02

**Fastness to rubbing** (ISO) dry 5, wet 4-5

**Pilling** Note 4-5, EN ISO 12945



kvadrat



## Revive 2

kvadrat

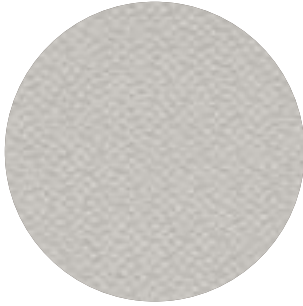

**Category A**

**Composition** 100% recycled polyester FR

**Weight** 420 g/lin.m

**Abrasion resistance** 45.000 Martindale rubs, EN ISO 12947

**Flammability** EN 1021-1/2 | DIN 4102 B1 | Önorm B1/Q1  
UNI 9175 1IM | US Cal. Tech. Bull. 117  
IMO A.652 (16)

**Fastness to light** Note 5-7, ISO 105-B02

**Fastness to rubbing** (ISO) dry 5, wet 4-5

**Pilling** Note 4-5, EN ISO 12945



## Terra



**Category B**

**Composition** 100% Pure New Wool

**Weight** 370 g/m<sup>2</sup> | 10.91 oz/yd<sup>2</sup>

**Abrasion resistance** 40.000 Martindale, 25,000 Wyzenbeek

**Flammability** EU: BS5852 CRIB 5 | BS5867 PART 2 : 2008 : TYPE B  
EN: 1021.2/2006 | USA: CAL TB 117

**Fastness to light** EU 5 | USA 5

**Fastness to rubbing** EU: Wet 4 | Dry 4

**Fastness to crocking** USA: Wet 4 | Dry 4



## Clara 2

kvadrat

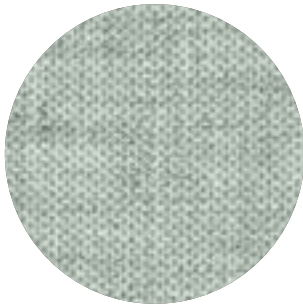

**Category B**

**Composition** 92% new wool, 8% nylon

**Weight** 400 g/lin.m

**Abrasion resistance** 80.000 Martindale rubs, EN ISO 12947

**Flammability** EN 1021-1/2 | BS 5852, ignition source 2-3 | DIN 4102 B2  
NF D 60 013 | UNI 9175 1IM | US Cal. Tech. Bull. 117, Sec. E  
NFPA 260 | IMO A.652(16)

**Fastness to light** Note 5-7, ISO 105-B02

**Fastness to rubbing** (ISO) dry 4-5, wet 4

**Pilling** Note 4, EN ISO 12945



## Remix 2

kvadrat



**Category B**

**Composition** 90% new wool, 10% nylon

**Weight** 415 g/lin.m

**Abrasion resistance** 100.000 Martindale rubs, EN ISO 12947

**Flammability** EN 1021-1/2 | BS 5852 part 1  
Önorm B1/Q1 | NF D 60 013 | UNI 9175, 1IM  
AS/NZS 1530.3 | Cal. Tech. Bull. 117-2013  
NFPA 260 | IMO FTP Code 2010:Part 8

**Fastness to light** Note 5-7, ISO 105-B02

**Fastness to rubbing** (ISO) dry 4-5, wet 4

**Pilling** Note 4, EN ISO 12945



## Hero

kvadrat

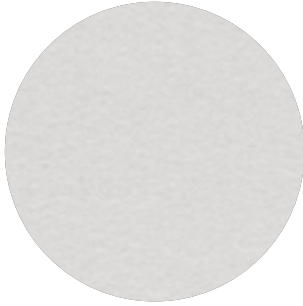

**Category C**

**Composition** 96% new wool, 4% nylon

**Weight** 580 g/lin.m

**Abrasion resistance** 45.000 Martindale rubs, EN ISO 12947

**Flammability** EN 1021-1/2 | DIN 4102 B2 | NF D 60 013  
UNI 9175 1IM | US Cal. Bull. 117-2013 | NFPA 260  
IMO A.652 (16)

**Fastness to light** Note 5-6, ISO 105-B02

**Fastness to rubbing** (ISO) dry 4-5, wet 4-5

**Pilling** Note 3-4, EN ISO 12945



## Tonus 4

kvadrat



**Category D**

**Composition** 90% new wool, 10% Helanca

**Weight** 665 g/lin.m

**Abrasion resistance** 100.000 Martindale rubs, EN ISO 12947

**Flammability** EN 1021-1/2 | BS 5852 part 1 | DIN 4102 B2  
Önorm B1/Q1 | NF D 60 013 | UNI 9175 1IM  
US Cal. Bull. 117-2013 | NFPA 260 | IMO A.652 (16)

**Fastness to light** Note 5-7, ISO 105-B02

**Fastness to rubbing** (ISO) dry 3-5, wet 3-5

**Pilling** Note 3, EN ISO 12945



## Memory 2

kvadrat

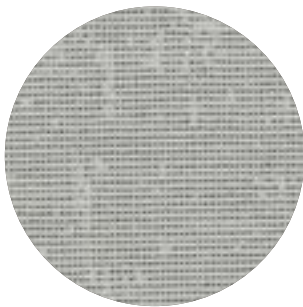

**Category E**

**Composition** 100% Trevira CS

**Weight** 700 g/lin.m

**Abrasion resistance**

35.000 rubs acc. to the Martindale method, EN ISO 12947

**Flammability** EN 1021-1/2 | DIN 4102 B1 | Önorm B1/Q1  
NF D 60 013 | NF P 92 507 M1 | UNI 9175 1IM  
UNI 9177 classe 1 | US Cal. Tech. Bull. 117  
IMO A.652 (16)

**Fastness to light** Note 5-8, ISO 105-B02

**Fastness to rubbing** (ISO) dry 4-5, wet 4-5

**Pilling** Note 4, EN ISO 12945



# Dimensions

## Acoustic Panel Round

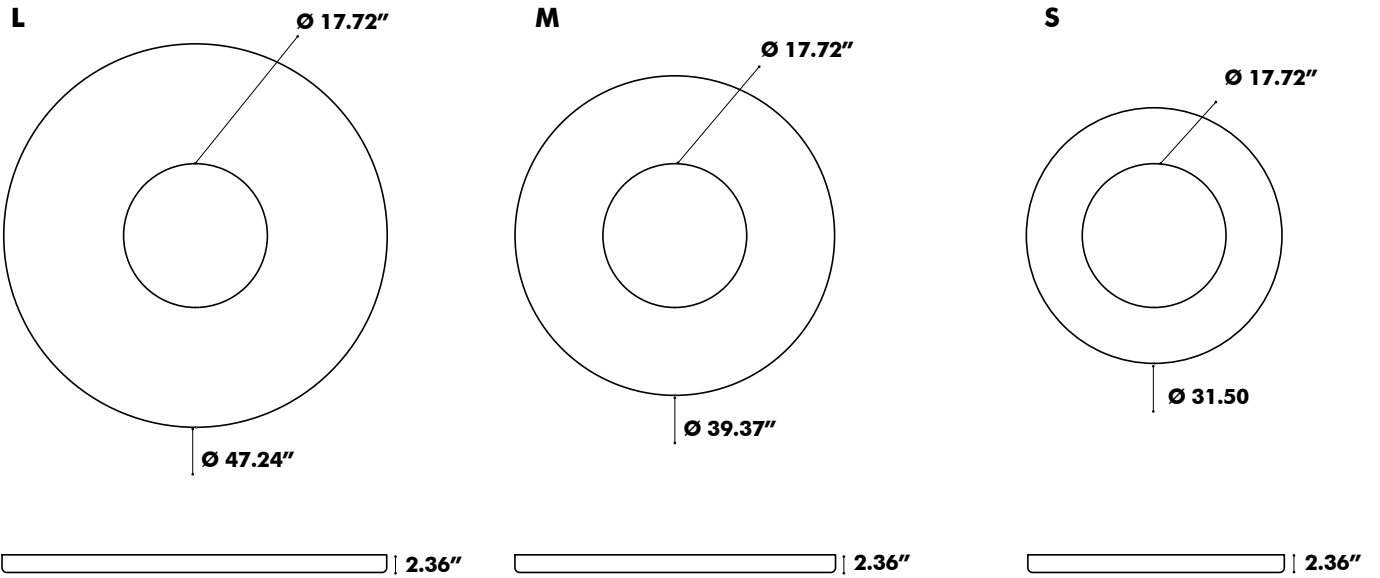

## Suspension Set Round

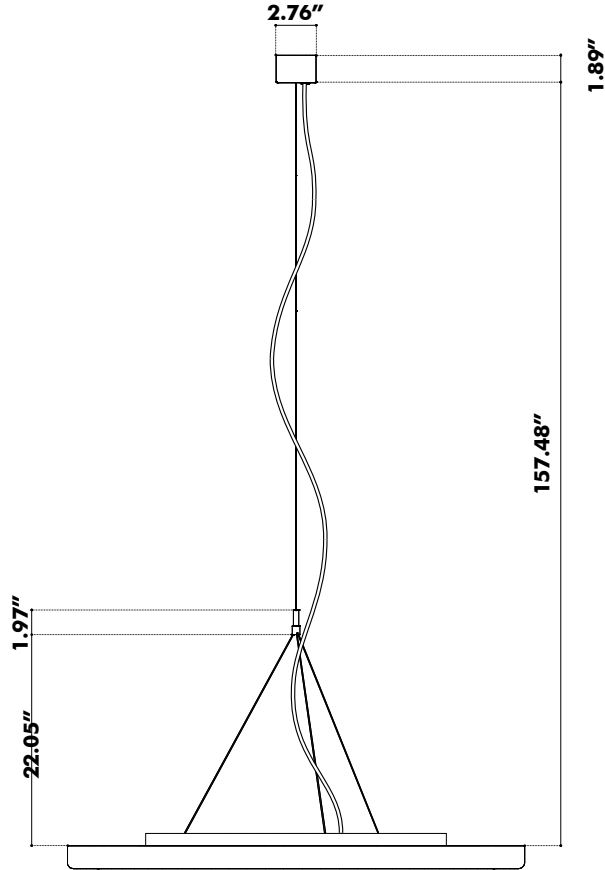

---

# Acoustic Panel Oval

M

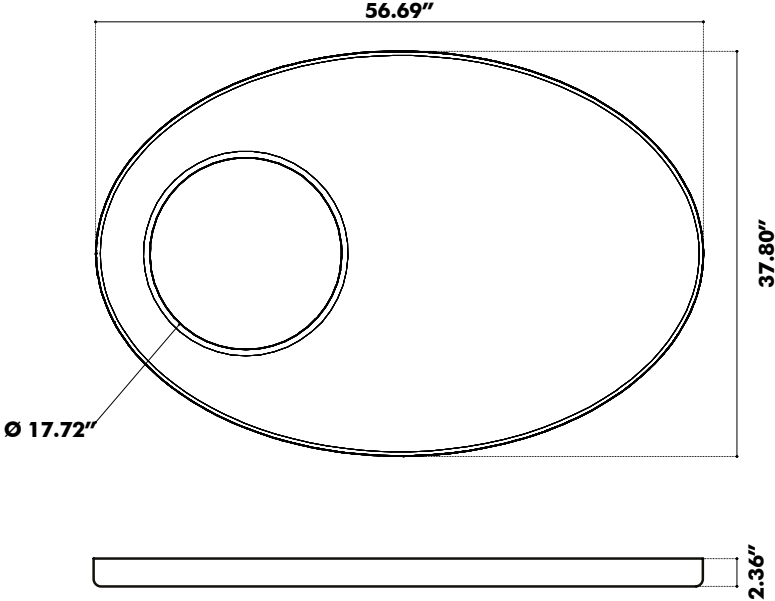

S

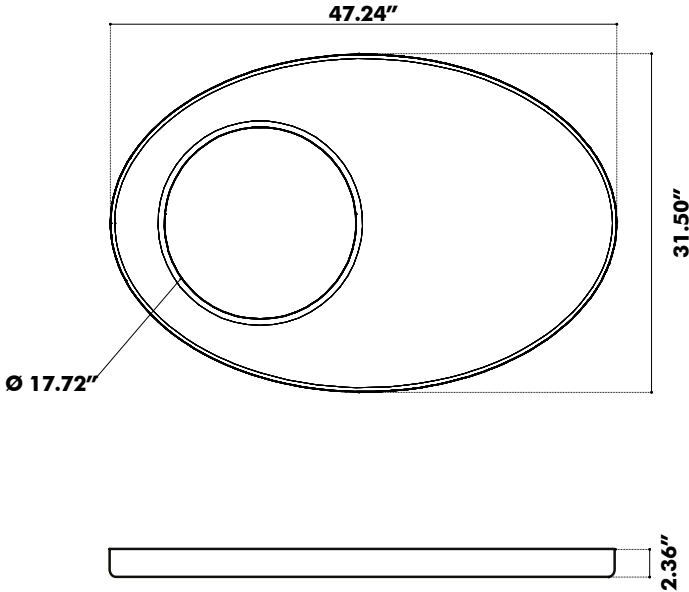

# Suspension Set Oval

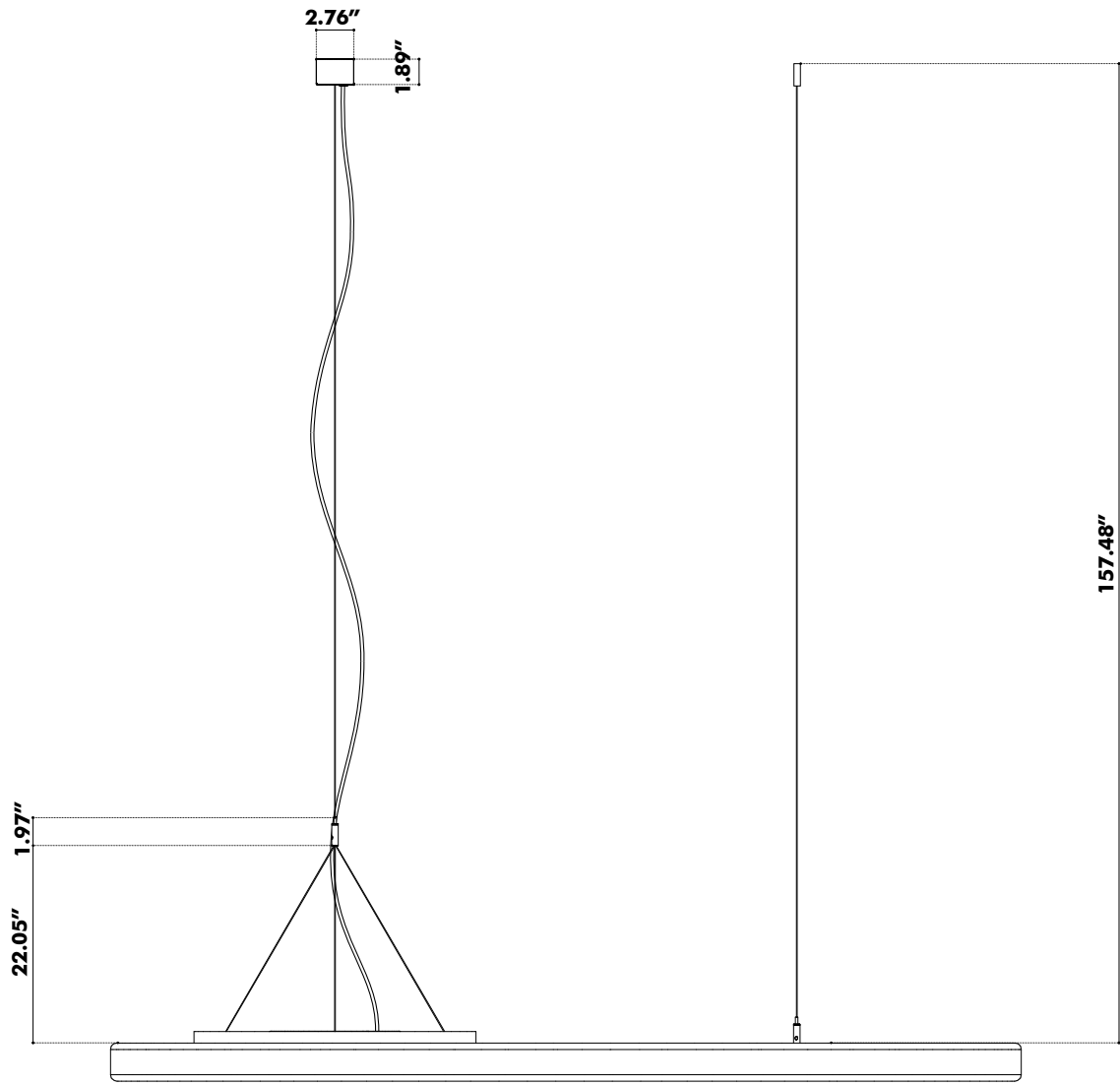

# Acoustics

## BuzziMoon Round

Equivalent sound absorption area in m<sup>2</sup> per object

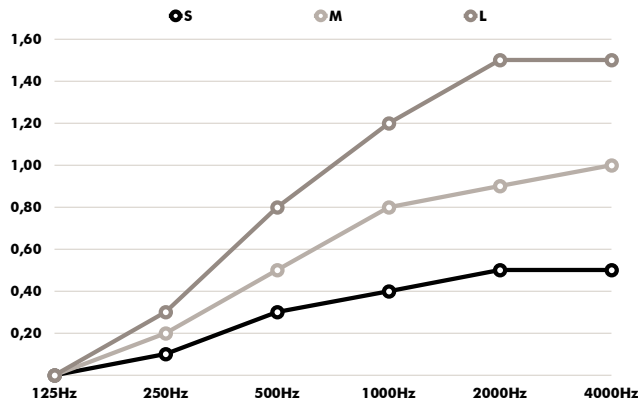

Hz	S Aeq/m <sup>2</sup>	M Aeq/m <sup>2</sup>	L Aeq/m <sup>2</sup>
125	0.0	0.0	0.0
250	0.1	0.2	0.3
500	0.3	0.5	0.8
1000	0.4	0.8	1.2
2000	0.5	0.9	1.5
4000	0.5	1	1.5

## BuzziMoon Oval

Equivalent sound absorption area in m<sup>2</sup> per object

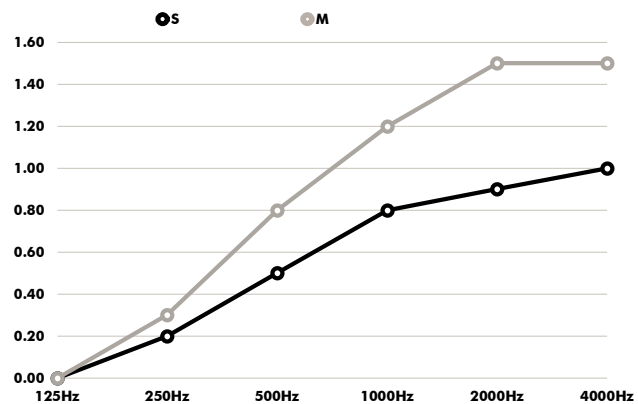

Hz	S Aeq/m <sup>2</sup>	M Aeq/m <sup>2</sup>
125	0.0	0.0
250	0.2	0.3
500	0.5	0.8
1000	0.8	1.2
2000	0.9	1.5
4000	1	1.5