

BuzziMoon

INSTALLATION MANUAL

120V

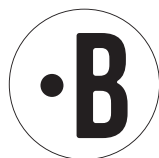
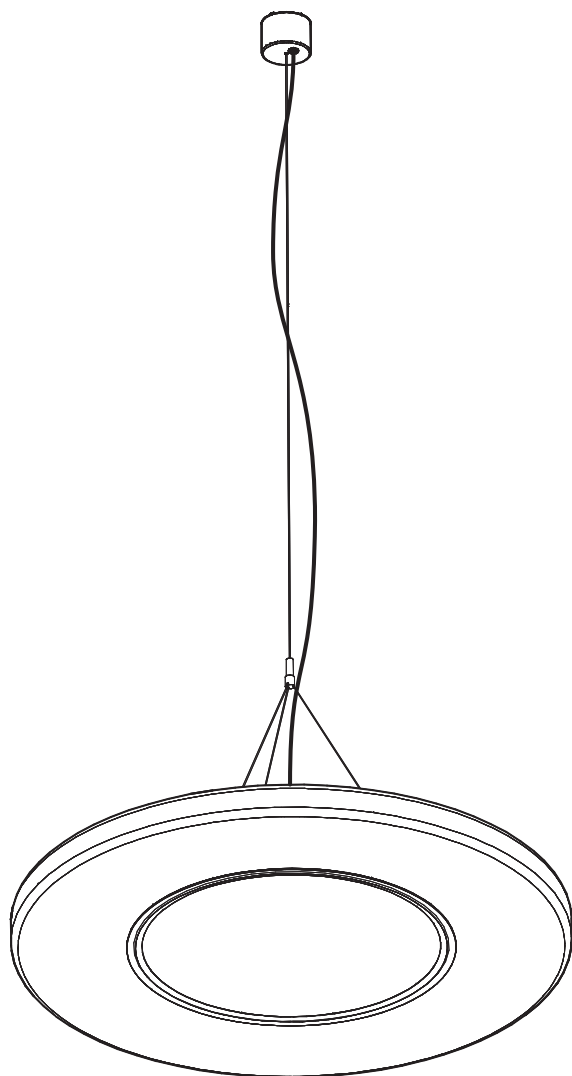

Technical info

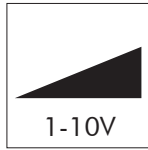
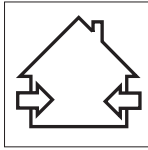

ASSEMBLE PART BUZZIMOON ACOUSTIC SHELL ONLY WITH PART 80000579

Excl.

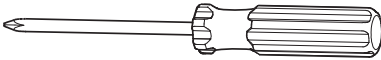
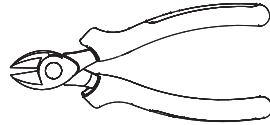
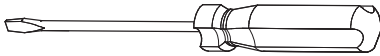

2x 

2x 

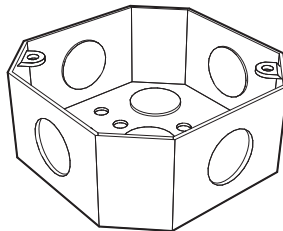

incl. BuzziMoon Pendant

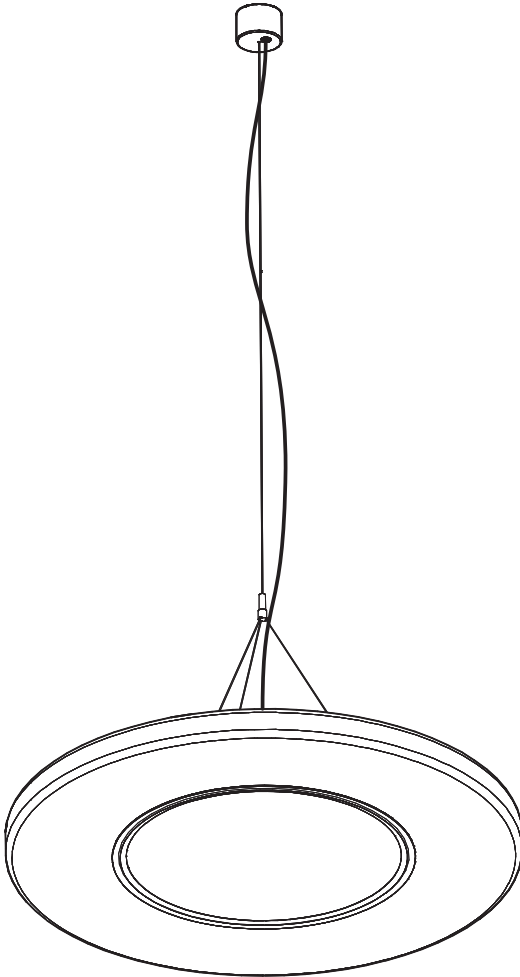
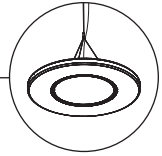

3x

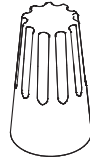

2x

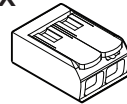

For dimmable function

1x

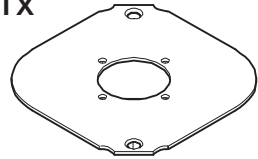

1x

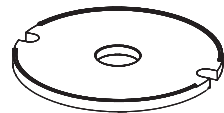

BuzziMoon Pendant

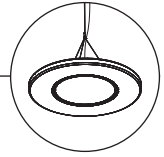

2 PERS. 

1

OFF

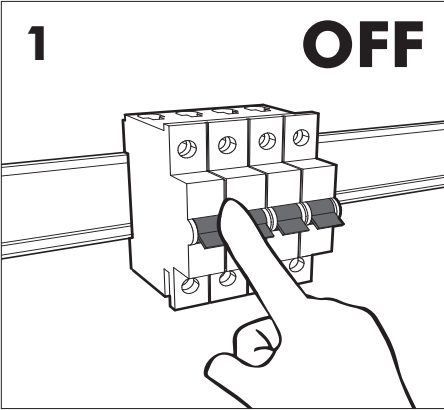

2

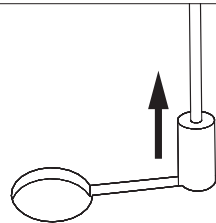
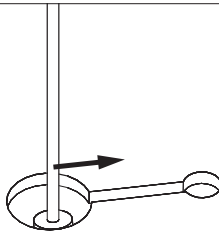
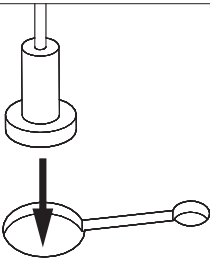
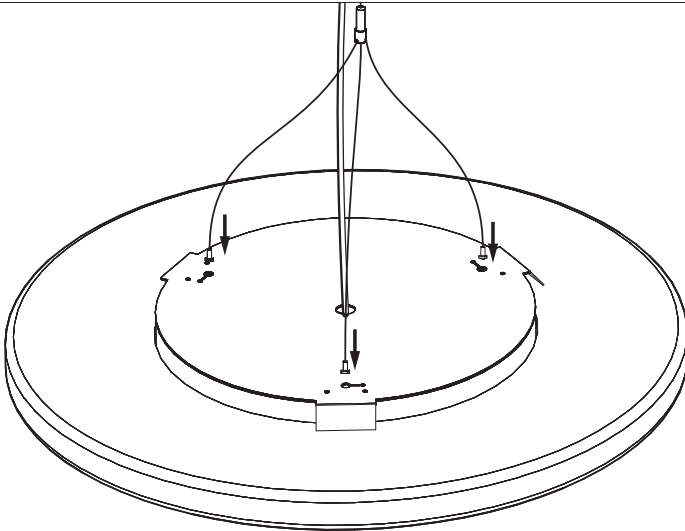

3

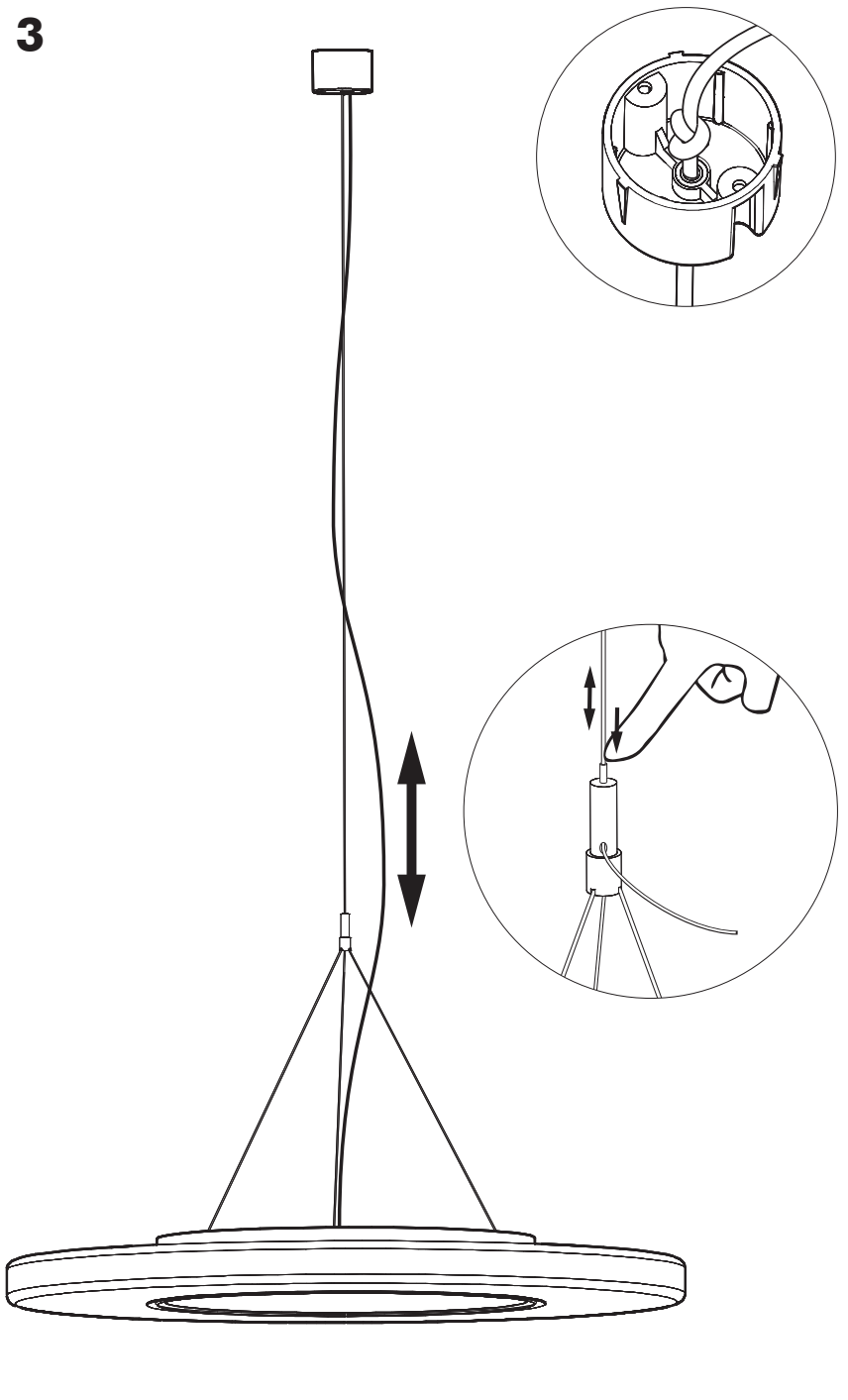

6

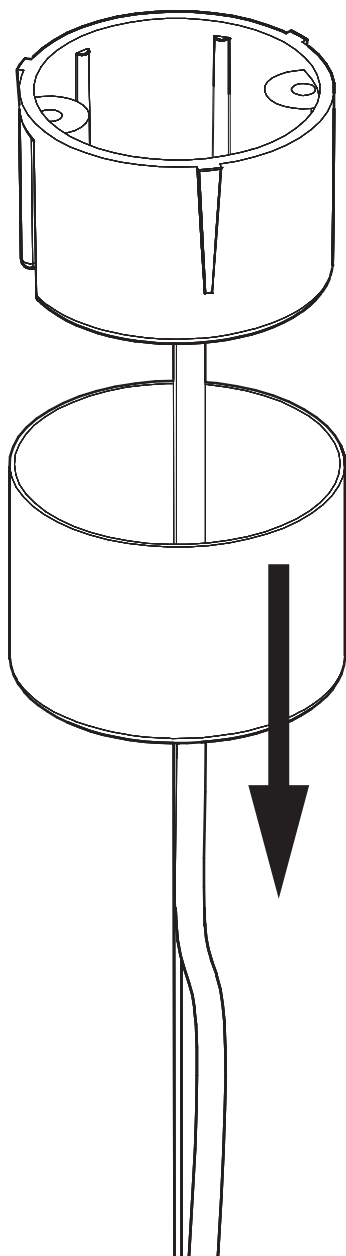

7a

Connection including dimmable function

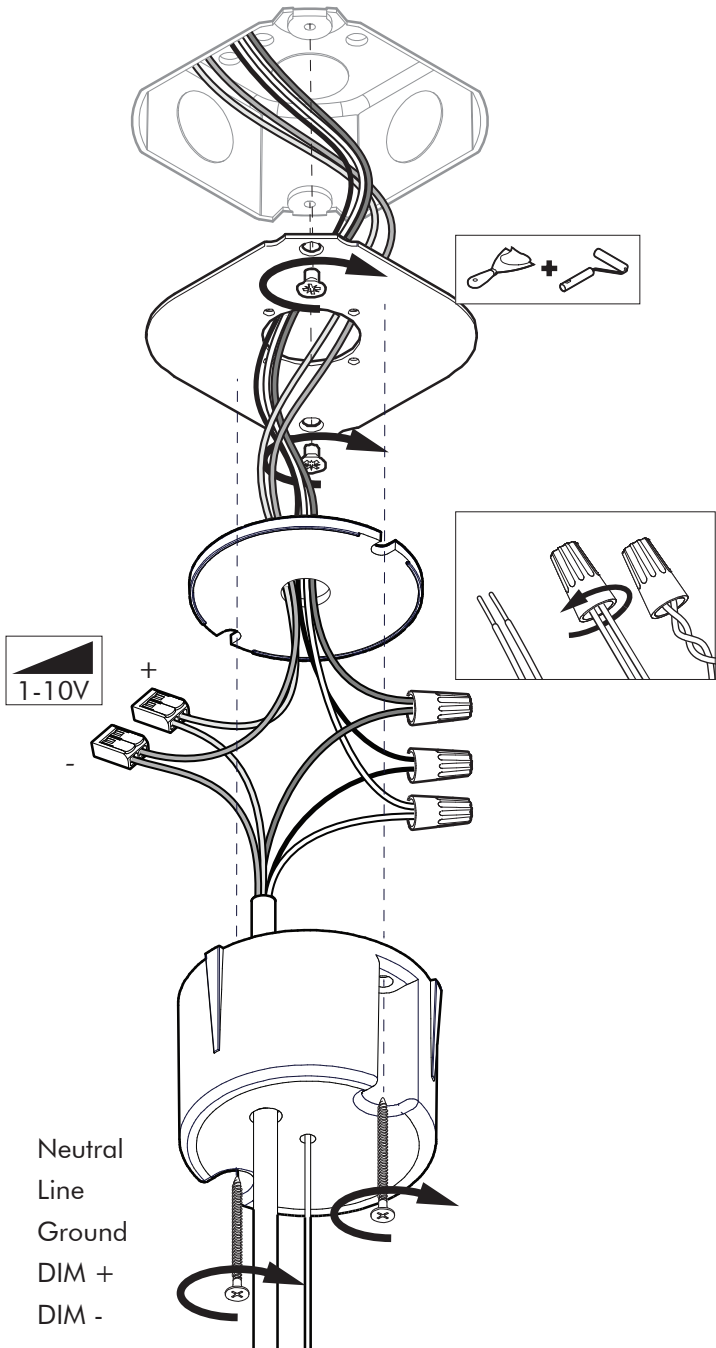

7b

Connection excluding dimmable function

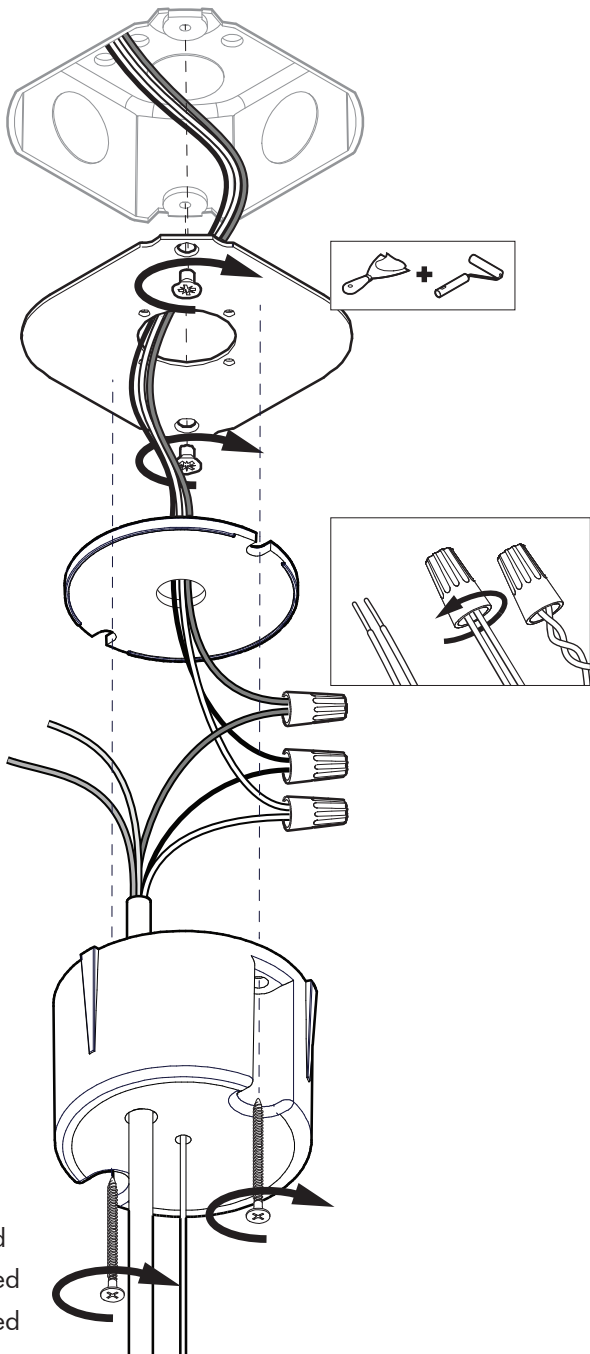

8

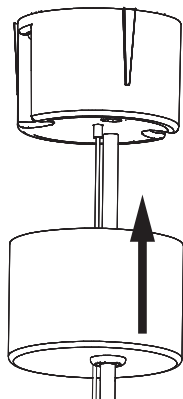

!

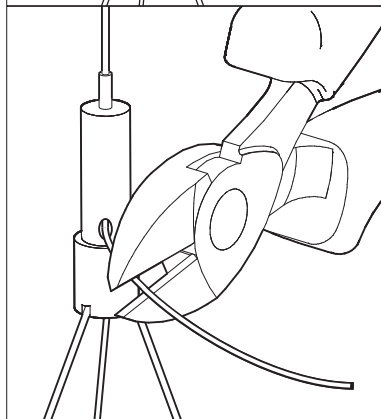
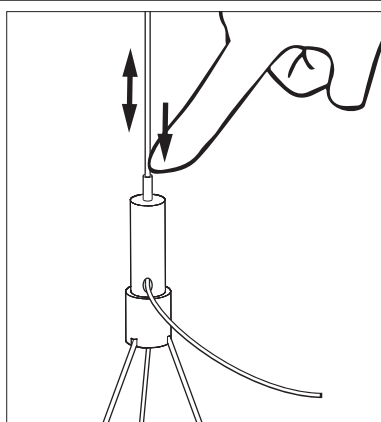
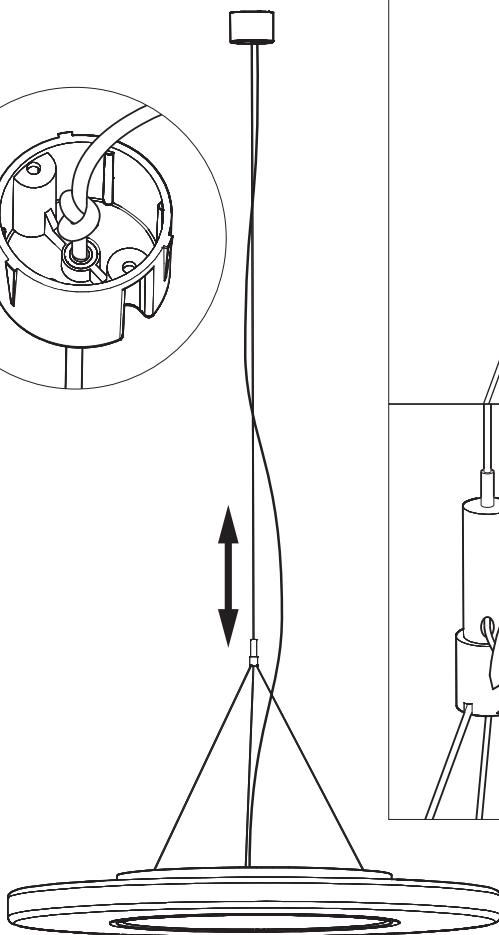
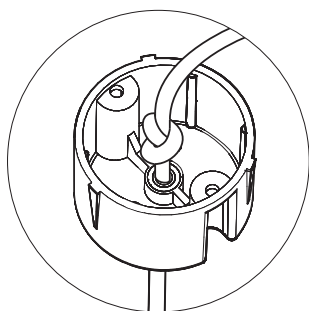

BuzziSpace
Groeningenlei 141
2550 Antwerp, Kontich
Belgium
☎ +32 (0)3 846 10 00
✉ info@buzzi.space
🌐 www.buzzi.space

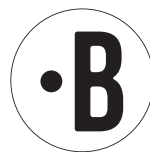

Doc nr.: A-0000001775/3
Last update: 18/04/2018